

NASA TECHNICAL NOTE



NASA TN D-3726

NASA TN D-3726

AN EVALUATION OF THE HANDLING QUALITIES OF SEVEN GENERAL-AVIATION AIRCRAFT

*by Marvin R. Barber, Charles K. Jones, Thomas R. Sisk,
and Fred W. Haise*

*Flight Research Center
Edwards, Calif.*

NATIONAL AERONAUTICS AND SPACE ADMINISTRATION • WASHINGTON, D. C. • NOVEMBER 1966

NASA TN D-3726

AN EVALUATION OF THE HANDLING QUALITIES OF
SEVEN GENERAL-AVIATION AIRCRAFT

By Marvin R. Barber, Charles K. Jones,
Thomas R. Sisk, and Fred W. Haise

Flight Research Center
Edwards, Calif.

NATIONAL AERONAUTICS AND SPACE ADMINISTRATION

For sale by the Clearinghouse for Federal Scientific and Technical Information
Springfield, Virginia 22151 - Price \$2.50

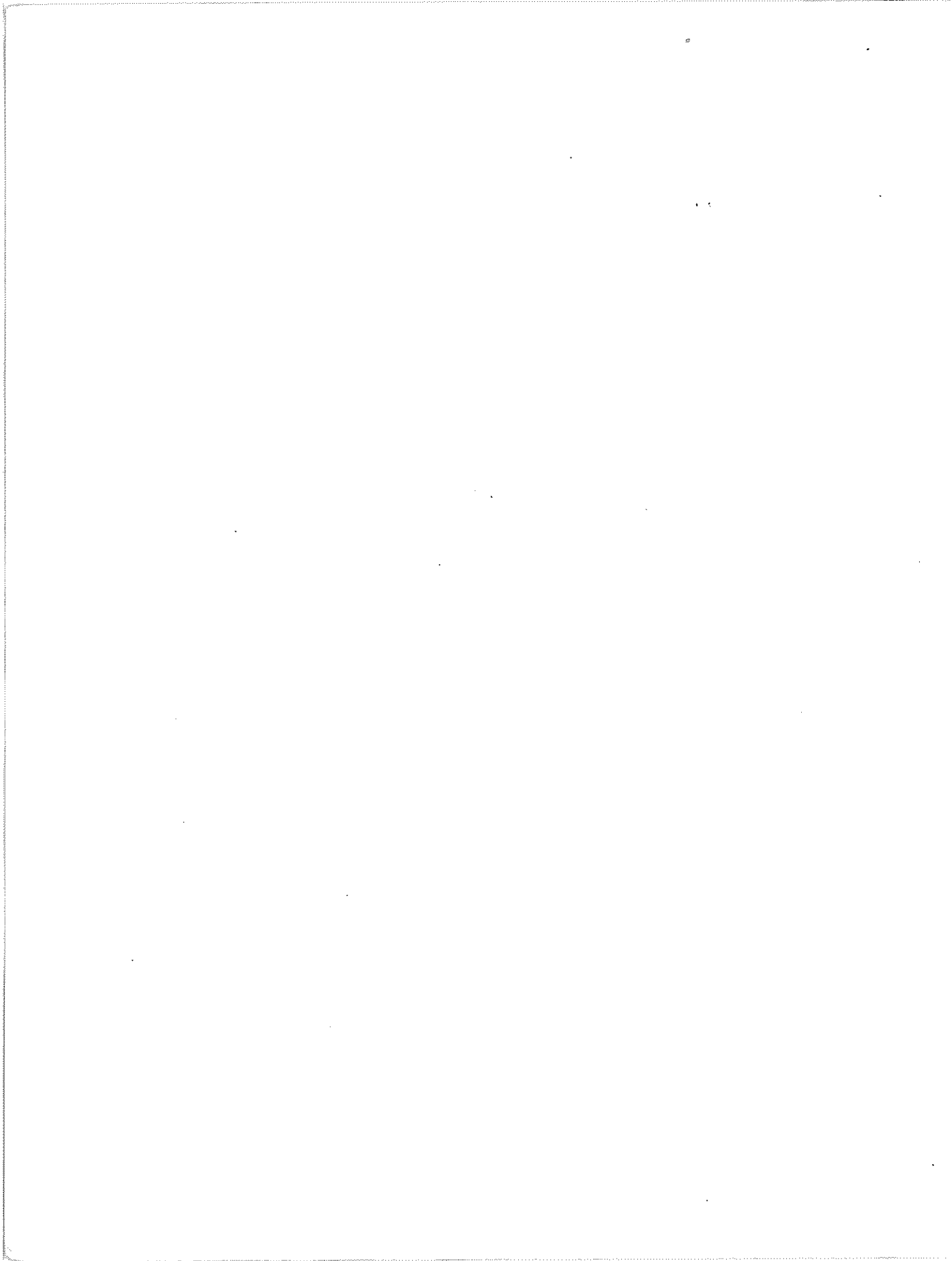

AN EVALUATION OF THE HANDLING QUALITIES OF
SEVEN GENERAL-AVIATION AIRCRAFT

By Marvin R. Barber, Charles K. Jones,
Thomas R. Sisk, and Fred W. Haise
Flight Research Center

SUMMARY

A quantitative and qualitative flight-evaluation program has been conducted on seven late-model general-aviation aircraft.

The quantitative portion of this program indicated that the aircraft, as a class, have generally satisfactory stability and control characteristics. However, these characteristics are degraded with decreasing airspeed, increasing aft center of gravity, increasing power, and extension of gear and flaps.

The qualitative portion of the program showed that the handling qualities are generally satisfactory during visual flight and during instrument flight in smooth air. Atmospheric turbulence degrades these handling qualities, with the greatest degradation noted during instrument landing system approaches. Such factors as excessive control-system friction, low levels of static stability, high adverse yaw, poor Dutch roll characteristics, and control-surface float combine to make precise instrument tracking tasks, in the presence of turbulence, difficult even for experienced instrument pilots.

The program revealed three characteristics of specific airplanes that are considered unacceptable if encountered by the inexperienced or unsuspecting pilot: (1) a violent elevator force reversal at reduced load factors in the landing configuration, (2) power-on stall characteristics that culminate in rapid rollovers and/or spins, and (3) neutral-to-unstable static longitudinal stability at aft center of gravity.

A review of existing criteria indicated that the criteria have not kept pace with aircraft development in the areas of Dutch roll, adverse yaw, effective dihedral, and allowable trim changes with gear, flaps, and power. This study indicated that criteria should be specified for control-system friction and control-surface float.

This program suggests a method of quantitatively evaluating the handling qualities of aircraft by the use of a pilot-workload factor.

INTRODUCTION

The handling qualities of five personal-owner aircraft were evaluated by the National Advisory Committee for Aeronautics in the 1940 time period (ref. 1). The characteristics measured in this study were compared with the criteria of reference 2. During the time since these investigations were made, this class of aircraft has undergone changes in both physical characteristics and operational use. Power and wing loadings have increased, the ratio of twin-engine to single-engine aircraft has increased, tricycle gear with a steerable nosewheel has replaced the conventional arrangement, and a greater number of control-system devices (such as downsprings and bobweights) have been incorporated in today's aircraft. Possibly a more important aspect than the physical changes is the increased use of these aircraft in adverse weather operations.

In view of the changing trends in design and operational use, and as a part of the national effort to improve general-aviation flight safety, the NASA Flight Research Center has completed a handling-qualities investigation of a representative cross section of present-day general-aviation aircraft, with emphasis on aircraft involved in adverse weather operations. The highlights of this investigation were reported in reference 3. The objectives of the program were to (1) evaluate the handling qualities of this class of aircraft in order to determine if the characteristics are satisfactory for the types of operations for which the aircraft are being used, (2) investigate in some detail those areas in which deficiencies are apparent, and (3) to determine if the criteria that are available are both applicable and adequate for this class of aircraft.

Seven different aircraft were included in the evaluation to assure that the measured handling qualities are representative of a class of aircraft rather than of an individual airplane. The stability and control characteristics of each aircraft were quantitatively documented and compared with pilot impressions of the aircraft's handling qualities. This paper summarizes the results of the evaluation and compares these results with current criteria considered to be applicable. Since the objectives were to evaluate handling qualities of the class of aircraft as a whole, characteristics documented herein have not been related to specific aircraft.

SYMBOLS

a_n	normal acceleration, g
b	wing span, feet
F_a	aileron force, pounds
F_e	elevator force, pounds
F_r	rudder force, pounds
g	acceleration due to gravity, 32.2 feet per second ²

h_p	pressure altitude, feet
I_X	moment of inertia about the principal X-axis, slug-foot ²
L	rolling acceleration, $\frac{\text{Rolling moment}}{I_X}$, radians per second ²
L_p	roll-damping parameter, per second
L_{δ_a}	roll-control-effectiveness parameter, $\frac{\partial L}{\partial \delta_a}$, per second ²
P	period, seconds
p	rolling angular velocity, degrees or radians per second
$\frac{pb}{2V}$	wing-tip helix angle for maximum roll rate, radians
q	pitching angular velocity, degrees per second
r	yawing angular velocity, degrees per second
$T_{1/2}$	time to damp to one-half amplitude, seconds
T_2	time to diverge to double amplitude, seconds
$T_{\varphi_{1/2}}$	time for bank angle to damp to one-half amplitude, seconds
T_{φ_2}	time for bank angle to double amplitude, seconds
$T_{\varphi=15^\circ}$	time for bank angle to reach 15°, seconds
t	time, seconds
V	true airspeed, feet per second
V_c	calibrated airspeed ($V_{ic} + \Delta V_{pc}$), knots
V_e	equivalent airspeed, feet per second
V_{ic}	indicated airspeed corrected for instrument error, knots
V_{mc}	minimum control speed, knots
ΔV_{pc}	airspeed position error, knots

V_S	stall speed for configuration tested, knots
α	angle of attack, degrees
β	angle of sideslip, degrees
$\frac{d\beta_{\max}}{d\delta_a}$	adverse-yaw parameter
γ	flight-path angle, degrees
δ_a	total aileron position, degrees or radians
δ_e	elevator position, degrees
δ_r	rudder position, degrees
ζ	damping ratio
τ_r	roll-mode time constant, seconds
φ	angle of bank, degrees
$\left \frac{\varphi}{v_e} \right $	rolling parameter, $\left \frac{\varphi}{v_e} \right = \frac{57.3}{V_e} \left \frac{\varphi}{\beta} \right $, degrees per foot per second
ψ	heading angle, degrees
ω	natural frequency, radians per second
Subscript:	
max	maximum

TEST PROGRAM

The flight evaluation consisted of two parts. The first part was devoted to a quantitative evaluation of the stability and control characteristics of the aircraft. This evaluation was restricted to in-flight characteristics and entailed approximately 13 flights per airplane. The tests encompassed evaluations of the static, maneuvering, and dynamic stability and control characteristics in the climb, cruise, approach, and landing configurations, as well as stalls and asymmetric power effects. The second part consisted of a qualitative pilot evaluation of the overall handling qualities, with particular emphasis on instrument flight operation, and entailed approximately 10 additional flights per airplane. The 23 evaluators included pilots from the Cornell Aeronautical Laboratory, Federal Aviation Agency, NASA, U. S. Air Force,

U. S. Navy, U. S. Army, and the light-aircraft industry. Each of the evaluators participated in an average of three flights.

Two of the aircraft were added when the program was near completion in order to assure inclusion of popular late-model aircraft with a high population index. In order to expedite this expansion, somewhat abbreviated programs (5 quantitative and 4 qualitative flights) were conducted on these aircraft.

* All of the aircraft underwent a weight and balance check, a pitot-static-system leak check, and an airspeed calibration over a measured ground course prior to the flight evaluation.

Of the variables considered, gross weight and altitude were found to have no significant effect on the handling qualities and were neglected. Therefore, all quantitative tests were performed at an altitude of 6000 feet. Tests were conducted with forward, mid, and aft center-of-gravity locations. Center-of-gravity position was controlled by using ballast. Shift due to fuel consumption was taken into account.

The initial trim conditions for each of the operational configurations tested were as follows:

<u>Configuration</u>	<u>Speed</u>	<u>Power, percent</u>	<u>Flaps</u>	<u>Gear</u>
Climb	1.4V _s	75	Up	Up
High-speed cruise	-----	75	Up	Up
Low-speed cruise	1.4V _s	(a)	Up	Up
Approach	1.4V _s	(a)	One-half	Down
Landing	1.4V _s	(a)	Full	Down

^aAs required for level flight.

TEST AIRPLANES

Pertinent physical characteristics of the test aircraft are presented in table I, and three-view drawings are presented in figures 1(a) to 1(c). These aircraft, as a whole, are considered to be representative of the general-aviation aircraft that are involved in instrument flying operations today. Included are both high- and low-wing configurations and both twin- and single-engine power plants. Wing loadings range from 17 to 31 pounds per square foot, and the average power loading is approximately 11 pounds per horsepower. These aircraft, in general, have less than three-axis trim capability and employ various control-system devices.

All seven airplanes have retractable tricycle gear with a steerable nosewheel, three controls (control wheel and pedals), constant-speed propellers, and are equipped for instrument flight. The four twin-engine airplanes are equipped with full-feathering propellers, and one aircraft is equipped with supercharged engines.

The static levels of control-system friction are presented in figure 2 for six airplanes. Figure 2(a) shows the friction band for all three controls of one aircraft for the range of control-surface deflection. These curves are considered to be

representative of the friction characteristics of all the aircraft. The levels of friction at zero control position (fig. 2(b)) average in excess of 2 pounds for the aileron, 20 pounds for the rudder, and almost 6 pounds for the elevator. It should be noted that the nosewheel was not in contact with the ground when these measurements were taken and was, therefore, free to rotate.

The control-surface rigging was not changed before the tests were made even though one aircraft did not have the maximum deflection specified by the manufacturer. The weight and balance checks showed that the empty-weight center-of-gravity locations given in each of the aircraft flight manuals are very close to the actual values. Pitot-static-system leaks were so small that they were of no consequence. The airspeed position errors¹ for all the aircraft are presented in figure 3. It can be seen that three aircraft have significant errors. Of these three, one aircraft has an appreciable error at the lower speeds and a significant change in error with configuration changes, whereas the errors of the other two aircraft are largest at higher speeds. It can be seen that one of these aircraft, at a corrected indicated airspeed V_{ic} of 160 knots, will actually be flying at 150 knots.

INSTRUMENTATION

Five of the aircraft were instrumented with standard NASA internal recording instruments synchronized by a common timer. The measured quantities consisted of the following:

- Elevator-, aileron-, and rudder-surface positions
- Wheel and pedal forces
- Pitching, rolling, and yawing angular velocities
- Normal, longitudinal, and transverse linear accelerations
- Angle of attack and angle of sideslip
- Bank angle and pitch attitude
- Indicated airspeed and pressure altitude

Angles of attack and sideslip were obtained from boom-mounted vanes on the wings of all the aircraft; these quantities were not corrected for angular velocities or boom bending. Recording accuracies were consistent with NASA instrumentation.

Recording instrumentation was not installed in the two aircraft on which abbreviated flight programs were conducted. Instead, pilot display and hand-held indicating types of instruments were used as follows:

<u>Parameter</u>	<u>Instrument</u>	<u>Estimated maximum error</u>
Control-surface positions	Taped scales on controls	±3° (surface)
Longitudinal control force	Hand-held force gage	±2 pounds
Directional control force	Rudder-pedal force gage	±20 pounds
Normal acceleration	Indicating normal accelerometer	±0.2g
Indicated airspeed	Airspeed indicator	±3 knots
Pressure altitude	Altimeter	±100 feet
Pitch attitude	Horizon (with side-window lines)	±3°
Bank angle	Artificial horizon	±3°

¹Position error is the error in indicated airspeed caused by the difference between the pressure (especially the static pressure) at the pressure-measuring location and the free-stream pressure.

RESULTS AND DISCUSSION

Stability and Control Characteristics

Inasmuch as handling qualities are the sum of the stability and control characteristics of an aircraft in terms of pilot opinion, it is necessary to determine these characteristics in order to assure proper assessment and evaluation of pilot comments. Therefore, a quantitative program, flown by a NASA project pilot, was conducted on each aircraft. The stability and control characteristics obtained are discussed in the following order: statics, maneuvering, and dynamics for both the longitudinal and lateral-directional modes.

Longitudinal statics.— Figure 4 presents the stick-fixed and stick-free static longitudinal characteristics for three aircraft--one with satisfactory gradients (fig. 4(a)) and two with marginal gradients (fig. 4(b)). Figure 4(a) also presents representative variations with center-of-gravity position and configuration. As shown, there is an appreciable lessening of both the stick-fixed and the stick-free stability gradients when the center of gravity is moved from the forward to the aft position; however, the gradients remain sufficiently high at the aft center-of-gravity position that the pilots consider them to be satisfactory. The variation of the stability gradients with configuration changes is small. These satisfactory characteristics are found on three of the seven aircraft tested. The other aircraft have satisfactory characteristics at high speeds; however, during low-speed flight in some of the climb, approach, and landing configurations with aft center-of-gravity loadings, the stability levels become very low. Two of the lowest levels observed are illustrated in figure 4(b). This figure shows one airplane, represented by the diamond symbols, to have near-neutral gradients in the approach configuration at the aft center of gravity. These marginal gradients greatly increase the pilot's workload during any type of precision flying and are considered to be unacceptable. The triangular symbols represent an airplane with a very low level of stick-fixed stability but, through the incorporation of a downsprung and bobweight, a high level of stick-free stability. The pilots commented that this aircraft is very responsive to both control inputs and gust disturbances, and that this responsiveness (or oversensitivity) makes the longitudinal characteristics unsatisfactory for precise tracking tasks. This study indicates that stick-fixed stability is necessary for satisfactory handling qualities.

Figure 5 shows the effects of power on the landing configuration stick-fixed and stick-free static longitudinal stability for the aircraft with the most pronounced power effects. It can be seen that the stick-free stability gradients are lowest in the power-on condition. If the power is cycled from approach to maximum at an airspeed of 80 knots, as might be done during an instrument waveoff, the pilot will have to push with a force of approximately 8 pounds to counter the resulting nose-up pitch. This characteristic also presents a problem when the power is being reduced in the landing phase. Figure 5 emphasizes the necessity of keeping power effects to a minimum. This point is discussed further in the Handling Qualities section.

Figure 6 presents the longitudinal trim changes with gear and flap extension for two aircraft--one considered to have satisfactory characteristics (fig. 6(a)) and the other unsatisfactory characteristics (fig. 6(b)). The trim changes illustrated in figure 6(a), which are representative of the aircraft tested, show a peak column pull

force of 15 pounds to maintain airspeed during flap extension, while the changes with gear extension are smaller. The pilots considered these trim changes to be satisfactory. The aircraft of figure 6(b) requires peak column push forces as high as 40 pounds during flap extension and 15 pounds during gear extension to maintain airspeed. Reference 4 shows trim changes with flap extension for another aircraft of this class as high as 55 pounds, which indicates that the aircraft evaluated in this study is not unique. References 2 and 5 allow trim changes of 50 pounds and 75 pounds, respectively. As a result of the pilot comments on the aircraft of figure 6(b), it would appear that both of these values are too large. The pilots commented that pull forces greater than 50 pounds required during gear and/or flap retraction (as in a missed approach) can result in disorientation and subsequent loss of control.

Lateral-directional statics. — The lateral-directional static-stability levels of the aircraft tested are lowest at low speed, as would be expected. Figure 7 presents the variation of aileron position and force (aileron-fixed and aileron-free stability) with angle of sideslip during constant-heading sideslip maneuvers for three aircraft. The variation of rudder position with sideslip is also shown in the figures to give a measure of the magnitude and linearity of the static directional stability and controllability. Figure 7(a) illustrates the effect of configuration change at constant airspeed on a representative airplane. Both aileron-fixed and aileron-free stability gradients are significantly lower in the landing configuration than in the low-speed cruise configuration. This reduction is noticeable on all of the aircraft tested.

When the flaps and gear are lowered to the landing configuration on three of the aircraft, the static lateral stability decreases to levels so low that the aircraft comply only marginally with the requirement of reference 5.¹ Figure 7(b) shows the stability gradients for two aircraft which have comparable low levels of aileron-fixed stability. The aircraft represented by the diamond symbols has a higher level of aileron-free stability because of the incorporation of a rudder-aileron interconnect. When the pilot deflects the rudder to induce a sideslip in the aircraft with the interconnect, a force is applied to the ailerons by the interconnect spring. The force deflects the ailerons in the direction to raise the low wing, thereby artificially increasing the lateral stability and making it possible for the aircraft to comply with the requirement by a broader margin. However, the level of aileron-fixed static lateral stability is not increased. The pilots commented that the lateral-stability characteristics of the airplane with the interconnect are not significantly improved over those of the airplane without the interconnect. Incorporation of the interconnect introduces a control problem during takeoff, which is discussed in a subsequent section.

Power effects, caused by propeller slipstream, can become quite large on this class of aircraft. Figure 8 illustrates the magnitude of these effects on one of the aircraft. At a speed of 110 knots, approximately 10° of rudder and 90 pounds of force are required to maintain heading when changing the power from maximum to idle. The pilots consider this magnitude of force change with power to be excessive. The lateral trim changes with power are negligible.

Lateral-directional trim changes with airspeed become appreciable at low speed (high angle of attack) at constant power. Data for an aircraft with highly unsatisfactory characteristics are shown for the maximum-power cruise and landing configurations

¹"The static lateral stability, as shown by the tendency to raise the low wing in a slip, must be positive for any landing gear and flap positions..."

in figures 9(a) and 9(b), respectively. These figures illustrate the large amounts of rudder control required to maintain wings-level constant-heading flight near the stall. This characteristic presents the pilot with a symmetric power minimum control speed that causes a significant problem when stalling the aircraft. Comparison of figure 9(b) with figure 9(a) shows that both configurations required maximum available rudder just prior to the stall; however, the rudder required to maintain heading in the landing configuration is generally greater at speeds below 80 knots.¹

Longitudinal maneuverability. - The longitudinal maneuvering stability is generally satisfactory for all the aircraft tested. Figure 10 presents the gradients of a representative aircraft. The figure shows the characteristic lessening of the stability gradients as the center of gravity is moved aft and illustrates the degree of nonlinearity typical of this class of aircraft. The stick-force gradients about 1 g are approximately 35 pounds per g at forward center of gravity and 19 pounds per g at aft center of gravity. Since most of the aircraft tested are certificated under the Normal Category of reference 5, they have limit load factors of 3.8g. By substituting this value in the Class II-L requirements of reference 6, it is determined that a maximum gradient of 43 pounds per g and a minimum gradient of 16 pounds per g are allowed. Not only did the pilots state that the levels of the aircraft of figure 10 were satisfactory, but they did not object to gradients as high as 45 pounds per g. These comments indicate that the range of values specified in reference 6 may be appropriate for aircraft of this class which have a wheel control. (It should be noted that acceptable gradients will vary between stick and wheel controls.)

Two of the aircraft tested have stick-force gradients as low as 5 pounds per g when the center of gravity is in the aft position. These two aircraft show greater nonlinearities at this aft position than shown by the class as a whole. The pilots commented that these low gradients allowed the limit load factor to be attained too easily.

In general, the gradients did not vary significantly with airspeed. The stick force required to produce a given acceleration in a rapid pullup is always higher than the force required to produce the same acceleration in a steady turn. This is an important factor in that it assures that the pilot will not "over-g" the aircraft by a sudden control input. References 7 and 8 discuss this area in some detail.

One aircraft exhibits an abrupt longitudinal force reversal (pitch down) in the landing configuration at reduced load factor. Figure 11 illustrates the abruptness of this reversal and shows that its onset occurs at approximately 0.35g. Figure 12 presents a time history of the pertinent longitudinal parameters during the force reversal and ensuing recovery response. This figure shows that the pilot was pulling on the control yoke within 1 second of the reversal, but that the pull force reached approximately 10 pounds before the elevator started up and was in excess of 50 pounds before the load factor started increasing.

Although this reversal occurs at 0.35g which is well outside the normal flight envelope, it could result in loss of control if encountered by the unsuspecting pilot. A reversal of this nature closer to the normal operating flight envelope would be entirely unacceptable.

¹Comparison of hangar calibrations with manufacturer's specifications showed that the rudder was misrigged on this airplane such that maximum rudder throw was 5° right and 7° left less than specified--a condition which aggravated the situation described.

Lateral-directional maneuverability.— The roll rates of all the airplanes are linear with control deflection and, in general, are of sufficient magnitude to meet the helix-angle criterion $\left(\frac{pb}{2V} \geq 0.07 \text{ radian}\right)$ specified in the Class II-L requirements of reference 6. Some of the aircraft have excessive adverse aileron yaw and one is sluggish in roll at low speeds.

Roll performance was measured in abrupt, rudder-fixed aileron rolls as shown in the time history of figure 13. This figure presents data for two aircraft that are rated by the pilots as having objectionable characteristics. One aircraft is sluggish in roll, the other has excessive adverse yaw.

Figures 14(a) and 14(b) summarize the rolling characteristics of the two aircraft shown in figure 13 in terms of wing-tip helix angle, reciprocal of time to reach a bank angle of 15° , and the maximum sideslip angle for right and left aileron rolls of various deflections. Data are presented for the low-speed cruise and landing configurations. As previously mentioned, both aircraft have helix angles in excess of 0.07 radian in the landing configuration, that are not significantly changed with configuration.

Sluggishness in roll is typified by low values of acceleration which delay attainment of maximum roll rates. This is emphasized by comparing the data for the two aircraft of figure 14, which shows the greater time required by the sluggish airplane to roll to a small bank angle. (The reciprocal of time to bank is presented to preclude discontinuity at zero aileron position.)

The Class II-L requirements of reference 6 specify that aircraft of this class be capable of attaining maximum roll rate in no more than $0.5 + \frac{b}{100}$ seconds after initiation of pilot control action. If an average value of 36 feet is used for the wing span (see table I), the time required to attain maximum roll rate should be no greater than 0.86 second for this class of aircraft. Referring again to figure 13, it can be seen that the sluggish airplane (dashed line) requires about 1.4 seconds to attain maximum rolling velocity as compared to 0.7 second for the other aircraft.

To further evaluate the sluggishness in roll, the characteristics of these two aircraft are compared in figure 15 with the proposed criterion of reference 9, which correlates pilot opinion with the maximum roll control power $L\delta_a \delta_{a_{\max}}$ and the roll-mode time constant τ_R .¹ While this criterion is for fighter-type aircraft and, therefore, not directly applicable (the pilot-opinion boundaries may shift because of aircraft mission), the data presented show a significant difference between the two aircraft. Reference 9 states that when τ_R is large and $L\delta_a \delta_{a_{\max}}$ is small, the pilots commented that the aircraft had sluggish response. The data presented show that the aircraft considered by the pilots to have sluggish response does have the larger values of τ_R and the smaller values of $L\delta_a \delta_{a_{\max}}$. The data also illustrate the decrease in roll power as speed decreases. A criterion of this type--that compares roll control power with roll-mode time constant--may prove to be the best means of stipulating aircraft roll performance.

¹ τ_R is inversely proportional to roll damping L_p . It is measured in the manner prescribed in reference 9.

Referring again to figures 14(a) and 14(b), it can be seen that changing configuration from cruise to landing causes an appreciable reduction in the adverse yaw. It should be noted that for full aileron deflection the aircraft of figure 14(a) still experiences 13° adverse yaw in the landing configuration. The pilots feel this amount is excessive for good handling qualities. The aircraft of figure 14(b) with maximum sideslip angles of approximately 8° in the landing configuration is considered to have satisfactory adverse-yaw characteristics.

Possibly more important than the yaw resulting from maximum aileron deflections is the yaw that results from the small deflections used during precise tracking tasks. Figure 16 presents $\frac{d\beta_{\max}}{d\delta_a}$ (slope at zero aileron position), which provides a means of evaluating the adverse yaw resulting from small deflections. This figure shows that the aircraft considered by the pilots to have satisfactory characteristics have generally lower values of $\frac{d\beta_{\max}}{d\delta_a}$ than the other aircraft. Although sufficient data are not available to define a boundary, it appears that this parameter may have merit for specifying acceptable levels of adverse yaw. It is interesting to note that the aircraft incorporating differentially deflecting ailerons had higher levels of this parameter than the other aircraft.

In summary, this study indicates that, for satisfactory handling qualities, airplanes of this class should (1) produce helix angles on the order of 0.07 radian, (2) have properly matched values of roll control power and roll-mode time constant, and (3) develop somewhat less than 10° adverse yaw in maximum aileron deflection rolls.

Longitudinal dynamics. - The short-period longitudinal oscillations of all the aircraft are well damped and satisfactory. The stick-fixed long-period (phugoid) oscillations are also well damped and satisfactory; however, two airplanes have divergent stick-free phugoids at the lower speeds which deteriorate as the center of gravity moves aft. Data for the airplane with the least damping are shown in figure 17 as a function of calibrated airspeed for two center-of-gravity positions. The stick-free damping is much lower than the range of stick-fixed damping, represented by the shaded area at the top of the figure, and deteriorates with aft center-of-gravity movement. This difference in damping is indicative of an elevator-float tendency that is aggravated by having an improperly matched bobweight/downspring moment ratio in the longitudinal control system. Although the divergent stick-free oscillations do not present a significant piloting control problem (because of their long period), they are a measure of the elevator-float tendency which adds to the overall pilot workload.

Downsprings and bobweights are installed in aircraft to obtain satisfactory longitudinal static and maneuvering force gradients over a wider range of center-of-gravity travel than can be realized with the basic control system. The devices used in the aircraft tested, in all cases, increased the stick-free stability gradients. Figure 18 shows the effects of a bobweight and a downspring on the static stability (fig. 18(a)) and maneuvering stability (fig. 18(b)) of the aircraft. Analysis of the figure shows that these devices change neither the static nor the maneuvering stick-fixed gradients, although the absolute magnitude of the elevator position is slightly altered to offset the added tab angle required to trim out the additional force. Both the bobweight and the downspring increase the stick-free static-stability gradients; the amount of increase is directly proportional to the amount of moment about the elevator hinge line added by

the device. Figure 18(b) shows that the bobweight increases the stick force but the downspring has no appreciable effect. The phenomena involved in increasing the stability gradients are discussed in detail in references 10 and 11.

Although bobweights and downsprings provide an expedient method of increasing stick-free gradients, if not properly matched they can cause the elevator-float tendency discussed earlier. This characteristic is illustrated in figure 19, which presents time histories of the primary longitudinal parameters during control-free oscillations that were initiated by sharp elevator pulses. The airspeed and altitude traces of figure 19(a) show that the aircraft of figure 18 experiences a divergent oscillation of approximately phugoidal period when the bobweight and downspring are installed. Analysis of the elevator position shows that it is floating and feeding the oscillation. Figure 19(b) shows that the same aircraft has convergent response and no elevator float when the bobweight and downspring are removed. A comparison of figures 19(a) and 19(b) indicates that some of the stability benefits gained by introducing bobweights and downsprings are lost because of the resultant elevator float. A floating elevator makes the airplane considerably more difficult and sometimes impossible to trim, causes an apparent lessening of the stability, and amplifies the airplane's response to turbulence. Reference 11 shows that elevator floating tendency can be minimized by using a proper bobweight/downspring moment ratio.

Lateral-directional dynamics.— The airplanes as a class are characterized by Dutch roll oscillations that are not sufficiently damped to provide the pilot with satisfactory handling qualities in turbulence. The oscillations of one aircraft at high speeds are severe enough to cause the pilot to be concerned about exceeding the allowable structural loads of the airplane.

Figure 20 presents the period and damping characteristics of the Dutch roll mode for three aircraft. Figure 20(a) shows that the aircraft with the most satisfactory characteristics has a period that varies, as the aircraft traverses the speed range, from 2 seconds to 4 seconds and a nearly constant time to damp to half amplitude that is less than 2 seconds. The airplane represented in figure 20(b) has the lowest damping of the aircraft tested. Although the periods for the two aircraft are about the same, the pilot's workload in the airplane with the lower damping is markedly increased in turbulence. Figure 20(c) shows the characteristics of an airplane with about the same damping as that in figure 20(a) but with a somewhat shorter period. Although the time to damp to half amplitude of the two aircraft is about the same, the airplane with the increased frequency experiences more cycles while a disturbance is damping. This increased number of excursions makes the pilot's workload almost as large as that of the poorly damped aircraft.

The characteristics were compared initially with the criterion of reference 6, which determines acceptability in terms of the inverse of the cycles to damp to one-half amplitude and the roll-to-sideslip ratios. This comparison revealed that the roll-to-sideslip ratios of all the aircraft were small ($0.2 < \frac{|\varphi|}{|v_e|} < 0.4$) and that all the data points fall in the satisfactory region. However, the pilots stated that all the aircraft are unsatisfactory, particularly for performing precise tracking tasks in the presence of atmospheric turbulence. Since the roll-to-sideslip ratios are small, these data were compared to the predecessor of reference 6 (U. S. Air Force Specification 1815-B), which considers only frequency and damping. This comparison

is shown in figure 21(a). Since this criterion also shows the aircraft to fall in the satisfactory region, it would appear that neither of these criteria will provide a good prediction of the lateral-directional dynamic handling qualities of this class of aircraft.

Figure 21(b) presents the same data shown in figure 21(a) in terms of the proposed criterion of reference 12. This criterion appears to be somewhat stringent because it indicates that the airplane with the low damping is unacceptable (note the adjective descriptions on the boundaries of figs. 21(a) and 21(b)). The pilots commented that all the aircraft are unsatisfactory for precise tracking tasks in turbulent air but indicated that none of the aircraft has unacceptable lateral-directional dynamic characteristics. Although the criterion is somewhat stringent, it offers better correlation with the pilot comments than the criterion of figure 21(a) regarding the relative satisfactoriness among the aircraft tested. The lack of agreement between the pilot comments and the three preceding criteria indicates the need for additional work in this area for this class of aircraft.

The control-fixed spiral characteristics in all cases are considered to be satisfactory for experienced instrument pilots. It is noted, however, that the control-free characteristics are appreciably degraded in aircraft having only longitudinal or longitudinal and directional trim systems when the effective dihedral becomes low. The lack of ability to trim the aircraft causes an apparent spiral motion that is more divergent than the aerodynamic spiral mode.

Figure 22 presents a time history of airspeed and bank angle during a typical control-free spiral maneuver for an aircraft with high rates of divergence and compares these data with the acceptance boundaries presented in reference 6. The reference specification states that the time to double amplitude shall be greater than 20 seconds in the cruise and approach configurations and greater than 4 seconds in all other configurations. It can be seen that this aircraft does not comply with the criteria. Pilots' comments indicate that, although it detracts from the overall handling qualities, the divergence rate measured is not considered to be dangerous.

It is interesting to note that, after the aircraft has reached a 30° bank angle and the speed has increased 8 knots, the rate of divergence decreases. This lessening of the divergence rate is typical of all the aircraft tested and is attributed to the lateral-directional trim change with speed.

The degradation of the control-free spiral motion in an aircraft that does not have sufficient trim capability is illustrated in figure 23. This figure presents the variation with indicated airspeed of the reciprocal of the time to damp to one-half (or time to double) amplitude for one airplane with only longitudinal trim capability and another with both longitudinal and lateral trim capability. The data for the aircraft without lateral trim capability were obtained from unpublished NACA data on an earlier model of the same aircraft. The improvement in the spiral characteristics is attributed to the improved trim capability.

Handling Qualities

To determine the effect of overall stability and control characteristics on handling qualities, a series of qualitative flights was performed on each of the aircraft tested. Twenty-three pilots with varied backgrounds and experience participated in the program.

Questionnaires individually oriented to visual flight and instrument flight tasks were provided. Comments and pilot ratings for the specific tasks of interest were requested. The rating system used was as follows:

<u>Letter rating</u>	<u>Descriptive adjective</u>
A	Very good, outstanding
B	Good, satisfactory
C	Acceptable but with some undesirable characteristics
D	Unsatisfactory

As seen, the rating system is in terms of commonly used adjectives. This simplified scale was introduced because some of the evaluation pilots were not familiar with the commonly used, but more complex, 10-point rating systems.

The test program encompassed the operational spectrum for visual and instrument flight--for example, takeoff, climb, cruise, descent, instrument approaches, and landing--and included special maneuvers such as stalls, asymmetric power tests, and mild aerobatics.

Takeoff and landing. - The takeoff and landing characteristics of these aircraft as a class are quite satisfactory, with most of the ratings falling between A- and B.

Pilot comments pointed out a problem during takeoff on the two aircraft that incorporated rudder-aileron interconnects. If the pilot holds in rudder to overcome torque or crosswind effects, the interconnect introduces an aileron control force that the pilot must anticipate and correct for to prevent the aircraft from rolling off in bank angle as it breaks ground.

The takeoff characteristics of one aircraft are undesirable when the manufacturer's recommended flap setting (one-half) is used. The aircraft is in a 5° nose-high position when in the three-point attitude. This angle positions the wing at an angle of attack which permits the aircraft to become airborne 5 to 10 knots before minimum control speed V_{mc} is reached. In an effort to delay flying until the minimum control speed is reached, the pilot reduces the angle of attack, which causes the main gear to leave the ground; consequently, the latter portion of the takeoff roll is completed on the nose gear. This makes lateral-directional control extremely difficult. During the tests, this problem was alleviated somewhat by using a zero flap setting for takeoff.

The nose-high attitude of this aircraft also complicates the landing maneuver. In order to keep from landing on the nose gear, the aircraft must be brought to within a few knots of the stall speed. If the speed is excessive (attitude too low), the nose gear impacts first, which results in a porpoising oscillation that persists for at least

three cycles and requires approximately 500 feet of runway before damping out. High longitudinal control forces further complicate the problem. At forward center of gravity, it is necessary to use full nose-up trim to keep the longitudinal force at a reasonable level. The attention given to the trimming task increases the probability of a nose-gear landing.

A pilot-induced longitudinal oscillation is experienced during the landing of one aircraft when at the aft center-of-gravity position. This oscillation is attributed to the low level of stick-fixed longitudinal stability (fig. 4(b)) coupled with the nose-down longitudinal trim change due to power reduction.

Cruise and approach in smooth air. - Figure 24(a) summarizes pilot ratings for both visual and instrument flight in smooth air. The instrument portion included level flight and maneuvering turns as well as instrument landing system (ILS) approaches; the visual flight covered only level flight and maneuvering turns. Ratings for high- and low-speed cruise and approach are shown.

The pilot-rating summary for the visual level flight and maneuvering turns, which included speed, heading, bank angle, and/or load-factor control as well as trimmability, shows the cruise configuration to range from A to B+. The ratings for the approach configuration range from B+ to C+, which indicates a general deterioration in handling qualities when the configuration is changed from cruise to approach. The variation in rating for each configuration is generally attributed to differences in center-of-gravity location, with the poorer rating corresponding to the more aft center of gravity.

The pilot ratings, in general, dropped one letter interval when the configuration was changed from cruise to approach in both visual and instrument flight conditions. This drop is due largely to an overall deterioration in the longitudinal (fig. 4) and lateral-directional (fig. 7) static stability as well as the longitudinal long-period dynamic characteristics.

In the precision approach (ILS), which requires exacting control of airspeed, heading, and rate of descent, the piloting task or workload is greater than for the other evaluation maneuvers. However, the pilot ratings in smooth air match those for the less-demanding instrument flight maneuvers.

Cruise and approach in turbulent air. - As noted earlier, atmospheric turbulence produces markedly lower pilot opinions of overall handling qualities. This effect is illustrated in figure 24(b), which shows the highest visual flight ratings to be reduced essentially one grade level from those in smooth air and the reduction for instrument level flight and maneuvering turns to be slightly more. The deteriorations with change in configuration show trends similar to the smooth-air ratings. Note in particular that the ratings for the ILS approach, as shown by the right-hand bar, are sharply downgraded to as low as an unsatisfactory D when light-to-moderate turbulence is encountered.

Visual-flight characteristics. - In general, it is difficult in visual level flight and maneuvering turns to achieve hands-off trim, both laterally and longitudinally, because of hysteresis and lack of sensitivity in the trim and basic control systems. It should be noted that the rudder-pedal friction force (fig. 2) is increased significantly by airloads when the nose gear is extended into the airstream. As a result, the aircraft

tend to diverge in roll, and airspeed is difficult to maintain within ± 5 knots. If the pilot does not coordinate turns with the rudder, the adverse yaw (fig. 16) resulting from lateral control inputs causes overshoots in effecting heading changes. Since great precision is not required during visual-flight operations, the pilot tends to allow airspeed, heading, altitude, and/or attitude to deviate from that desired and tightens his control in the loop only when required to achieve a higher performance level. The pilots commented on the increased workload and the bothersome oscillations in the presence of turbulence but agreed that there are no dangerous tendencies.

Instrument-flight characteristics. — The pilot ratings for level flight and maneuvering turns while "under the hood" were essentially the same as for visual flight, including the reduction of ratings by a one-letter interval for a configuration change from cruise to approach. The significant differences between the simulated instrument tasks and the related visual-flight tasks are attributed to the pilot's instrument display and trim-system characteristics.

All of the aircraft have undesirable and inconsistent placement of both primary flight instruments and navigational displays, which increases the pilot's instrument-scan workload. On some aircraft, excessive precession was noted in the directional-gyro and the artificial-horizon instruments. The latter instrument also tumbled in steep bank angles and pitch attitudes, such as those encountered in an unusual position. Trim systems are, in general, insensitive and poorly located. These factors combine to noticeably increase the pilot's workload as well as to cause unnecessary head movement, which can induce vertigo. The pilots complained about difficulty in achieving good lateral hands-off trim, particularly on the aircraft with only longitudinal and directional trim systems. For these aircraft, the pilot is forced to deliberately induce sideslip with the directional trim in order to hold the wings level. On two aircraft in the approach and landing configuration, the effective dihedral is reduced to the point where the pilot can position the directional trim to its maximum displacement and not obtain any significant effect in the lateral plane. On one of the aircraft these directional-trim manipulations produce a longitudinal trim change as well. With this out-of-trim condition, an apparent highly divergent spiral mode exists and there is a tendency for the aircraft to roll if the pilot diverts his attention momentarily while tuning a radio, reading a navigational chart, or performing other tasks.

Precision instrument (ILS) approaches. — For all the aircraft with an aft center-of-gravity position, and in the presence of turbulence, the pilot is alternately forced to divide his attention between the glide-slope and azimuth control problems. As the pilot focuses on the glide-slope task, heading control deteriorates. Because of the continual Dutch roll oscillations (figs. 20 and 21), there is no opportunity for the aircraft and instruments to settle out between gusts. In trying to make small heading changes, the pilot tends to overshoot as a result of the adverse yaw generated with corrective lateral-control inputs. The overshoot causes a momentary delay between control input and visible heading change on the directional gyro compass. When the pilot uses ailerons, the adverse yaw excites the Dutch roll oscillations as well. With heading constantly rocking back and forth $\pm 5^\circ$, the pilot must integrate these deviations in making a heading correction to assure that the oscillation is symmetric about the new desired heading. Heading drift also results from poor lateral-trim capability, with the aircraft tending to roll off in bank angle. On the other hand, when azimuth control requires immediate attention, gusts, coupled with elevator-surface float, tend to excite the phugoid mode with resultant variations in airspeed and rate of descent.

It is easy, in attempting to counteract this tendency, to add another problem by making power changes which result in longitudinal trim changes (fig. 5). With this type of workload, the pilot usually overshoots or allows a subsequent drift of the azimuth and glide-slope needles from the center position. It should be pointed out that the additional workload entailed in communicating with the ground control facility was handled by the safety pilot on most of these flights.

In smooth air, the pilots generally maintained the glide-slope and azimuth indicator needles within a 2-dot (half scale) dispersion; however, in light-to-moderate turbulence, there are occasional full-scale needle deviations ($\pm 2 \frac{1}{2}^\circ$ for azimuth, $\pm 1 \frac{1}{2}^\circ$ for glide slope).

Pilot workload. - It has been shown that the stability and control characteristics of the airplanes are generally satisfactory but deteriorate with reduced speed, increased power, aft center-of-gravity location, and changes to the landing configuration. Also, the handling qualities (as reflected in pilot opinion) deteriorate with degradation in stability and control and are critically degraded in turbulent air. Since, in general, each stability and control deterioration is relatively small, it is reasonable to assume that the reduced pilot rating results from the summation of all the deteriorations. Therefore, it is necessary to consider the combined effect of all the stability and control characteristics in order to properly assess the pilot ratings.

One means of assuring that the total problem has been considered is to examine the pilot workload. Several simulated ILS approaches were recorded during the investigation. In reviewing the time histories of these maneuvers, a correlation between pilot rating and the summation of the force inputs about all three axes was noted. This correlation is illustrated in figures 25(a) and 25(b), time histories of pertinent pilot input and airplane response parameters during 30 seconds of the latter part of simulated ILS approaches.

Both of the approaches were flown by the same pilot in essentially identical air masses, that is, very light turbulence. Figure 25(a) represents an airplane with high adverse yaw and low effective dihedral that was considered to be satisfactory by the pilots. Figure 25(b) represents an unsatisfactory airplane with high adverse yaw, sluggish response in roll, poor Dutch roll characteristics, low stick-fixed longitudinal stability, and elevator float. Note the relative increased activity of the elevator-, aileron-, and rudder-force curves of the unsatisfactory airplane. This figure suggests that a summation of the force inputs for both time histories will show a correlation between pilot workload and the stability and control deficiencies. Such a summation is shown in figure 26 in terms of pilot workload factor, where

$$\text{Workload factor} = \int_{t=0}^{t=30} |F_e| dt + \int_{t=0}^{t=30} |F_a| dt + \int_{t=0}^{t=30} |F_r| dt$$

The satisfactory airplane presents a workload factor of approximately 300; whereas, the unsatisfactory airplane approaches a factor of 500. Note that the magnitude of these factors suggests a possible inverse correlation with the corresponding pilot ratings of B- and C-.

Unfortunately, sufficient data were not available to indicate that such a correlation will exist for all cases. Admittedly, a workload factor based only on pilot force inputs has some deficiencies. However, the correlation indicated suggests that a workload concept using the proper parameters may provide a means of quantitatively evaluating the effect of individual stability and control characteristics on the pilot's ability to fly the aircraft.

Stalls. - Two of the aircraft tested have unacceptable power-on stall characteristics in the landing configuration. The lateral-directional trim changes of one aircraft show that the addition of power introduces a left yawing moment (fig. 8) and that the pilot must use full-right rudder to maintain heading when near the stall speed (fig. 9). The large yawing moment due to power coupled with the lack of rudder authority causes the aircraft to encounter an uncontrollable left roll/yaw motion at the stall. This motion places the aircraft in a spin that requires 600 feet to 1200 feet of altitude for recovery. All of the evaluation pilots exceeded the gear and flap placard speeds when recovering from this spin.

Another aircraft has a rapid left rolloff in the power-on accelerated stall with landing flaps extended. The rolloff is difficult to stop in less than 60° to 70° of left bank without anticipation and instantaneous recovery control on the part of the pilot. Such a stall may occur when a pilot tightens his final turn in the landing pattern to prevent overshooting the runway. From a left turn, the attendant rolloff, on occasion, proceeded to a nearly inverted attitude that required 200 feet to 300 feet of altitude to recover. This altitude loss would, obviously, be excessive in a landing approach. Instrument-flight recovery from the stall in either of these aircraft would be compounded by the tumbling of the attitude gyro.

Almost all of the aircraft lack good stall warning in the form of natural airframe aerodynamic buffet. As a result, all the aircraft except one incorporate some type of artificial stall-warning device. Four of the aircraft have warning horns and two are equipped with warning lights. The pilots considered the red-light visual-type of warning devices to be unsatisfactory; in some instances they become worthless because of glare from the sun.

Asymmetric power. - Handling qualities, including the dynamic case of sudden engine failure on takeoff and during 75-percent power cruise, were reported to be satisfactory in both visual and simulated instrument-flight conditions. It should be pointed out that asymmetric power stalls were not evaluated on all of the aircraft.

CONCLUDING REMARKS

A quantitative and qualitative evaluation of the handling qualities of seven late-model personal-owner aircraft indicates that these aircraft have generally satisfactory stability and control characteristics that deteriorate with decreasing airspeed, increasing aft center-of-gravity position, increasing power, and extension of gear and flaps. During visual flight, and during instrument flight in smooth air, the handling qualities are satisfactory. Atmospheric turbulence degrades these handling qualities. The degradation is most noticeable during instrument landing system approaches because of the marked increase in pilot workload. Excessive control-system friction, low levels of static longitudinal and lateral stability, high adverse yaw, objectionable

Dutch roll characteristics, and control-surface float combine to make precise instrument tracking tasks, in the presence of turbulence, difficult even for experienced instrument pilots.

The following three characteristics of specific airplanes are considered to be unacceptable if encountered by the inexperienced or unsuspecting pilot: (1) the violent elevator force reversal exhibited by one airplane at reduced load factor in the landing configuration, (2) the power-on stall characteristics of two aircraft--one that experiences a rapid rolloff that often results in excessive altitude loss for recovery, and the other that culminates in a spin--and (3) the neutral-to-unstable static longitudinal characteristics of a fourth airplane at the aft center-of-gravity position that makes instrument approaches in turbulence extremely difficult.

A review of existing handling-qualities criteria indicates that the criteria have not kept pace with aircraft development in the areas of Dutch roll, adverse yaw, static lateral stick-fixed stability (effective dihedral), and allowable trim changes with gear, flaps, and power. It appears that more stringent criteria for control-system friction and control-surface float are needed to improve overall handling qualities. The effect of atmospheric turbulence should be considered when criteria are established for this class of aircraft.

This program suggests a method of quantitatively evaluating the handling qualities of aircraft by the use of a pilot workload factor.

Flight Research Center,
National Aeronautics and Space Administration,
Edwards, Calif., August 19, 1966
126-16-01-05-24

REFERENCES

1. Hunter, Paul A. : Flight Measurements of the Flying Qualities of Five Light Airplanes. NACA TN 1573, 1948.
2. Gilruth, R. R. : Requirements for Satisfactory Flying Qualities of Airplanes. NACA Rept. 755, 1941.
3. Barber, Marvin R. ; Haise, Fred W. ; and Jones, Charles K. : An Evaluation of General Aviation Aircraft Flying Qualities. Paper No. 660219, SAE, 1966.
4. Hannegan, E. A. : Combined Stability and Control and Aircraft and Engine Performance Trials of the Model U0-1 Airplane. Report No. 1 - Flying Qualities and Performance Phases, Final Report. U. S. Naval Air Test Center (Patuxent River, Md.), Feb. 15, 1961.
5. Anon. : Part 23— Airworthiness Standards: Normal, Utility, and Acrobatic Category Airplanes. FAA, 1964.
6. Anon. : Flying Qualities of Piloted Airplanes. Military Specification MIL-F-8785(ASG), Sept. 1, 1954; Amendment -4, Apr. 17, 1959.
7. Phillips, William H. : Appreciation and Prediction of Flying Qualities. NACA Rept. 927, 1949.
8. Johnson, Harold I. : Flight Investigation to Improve the Dynamic Longitudinal Stability and Control-Feel Characteristics of the P-63A-1 Airplane (AAF No. 42-68889) With Closely Balanced Experimental Elevators. NACA WR L-730, 1946. (Formerly NACA MR L6E20.)
9. Creer, Brent Y. ; Stewart, John D. ; Merrick, Robert B. ; and Drinkwater, Fred J. , III: A Pilot Opinion Study of Lateral Control Requirements for Fighter-Type Aircraft. NASA Memo 1-29-59A, 1959.
10. Perkins, Courtland D. ; and Hage, Robert E. : Airplane Performance - Stability and Control. John Wiley & Sons, Inc. , 1957.
11. Goldberg, Joseph H. : Effects of Spring and Inertia Devices on the Longitudinal Stability of Aircraft. WADC Tech. Rep. 53-350, Wright Air Development Center, U. S. Air Force, July 1953.
12. Mazza, C. J. ; Becker, William ; Cohen, Marshall ; and Spector, Alvin: Proposal for a Revised Military Specification, "Flying Qualities of Piloted Airplanes" (MIL F-8785 ASG), With Substantiating Text. Rep. No. NADC-ED-6282, Eng. Dev. Lab. , U. S. Naval Air Dev. Center (Johnsville, Pa.), Jan. 18, 1963.

TABLE I. - PERTINENT PHYSICAL CHARACTERISTICS OF THE AIRCRAFT TESTED

	Aircraft					
Wing -						
Location	High	High	Low	Low	Low	Low
Loading, lb/sq ft	31.4	17.7	29.1	18.3	20.2	18.2
Area, sq ft	255.0	175.5	175.3	207.6	178.0	177.6
Span, ft	49.04	36.58	36.93	37.15	35.98	33.46
Mean aerodynamic chord, ft	4.88	4.98	5.08	5.58	5.00	5.44
Power -						
Horsepower/engine	380	285	260	160	160	285
Number of engines	2	1	2	2	2	1
Loading, lb/hp	10.5	10.9	9.8	11.9	11.3	11.6
Weight and balance -						
Maximum gross weight, lb	8000	3100	5100	3800	3600	3300
Empty gross weight, lb	5800	1830	3060	2730	2160	1880
Center of gravity for maximum gross weight, percent mean aerodynamic chord	22.0 to 32.0	22.6 to 35.4	23.6 to 33.1	21.4 to 28.6	12.5 to 21.6	23.6 to 27.5
Center of gravity for empty gross weight, percent mean aerodynamic chord	22.0 to 32.0	12.2 to 35.4	15.1 to 34.1	12.9 to 28.6	3.3 to 21.6	15.8 to 29.1
Control-system devices -						
Elevator downspring	✓ ^a	✓	✓	✓	✓	✓
Elevator bobweight	✓	✓	✓	✓	✓	✓
Rudder-aileron interconnect	✓	✓	✓	✓	✓	✓
Differentially deflected ailerons	✓	✓	✓	✓	✓	✓
Adjustable trim systems -						
Longitudinal	Tab	Tab	Tab	Bungee	Tab	Tab
Lateral	Tab	Bungee	Tab	Tab	Bungee	Bungee
Directional	Tab	Tab	Tab	Tab	Bungee	Bungee
Control-surface deflection, deg -						
Elevator	33 up, 13 down	28 up, 17 down	16 up, 16 down	20 up, 15 down	14 up, 4.5 down	29 up, 20 down
Aileron:						
Total	±38	±36	±40	±48	±32	±40
Differential	23 up, 15 down	22 up, 14 down	20 up, 20 down	32 up, 16 down	18 up, 14 down	20 up, 20 down
Rudder	23 right, 20 left	±25	±32	±29	22 right, 20 left	±26
Flap (full)	40	40	35	50	27	30

^aCheck mark indicates device installed.

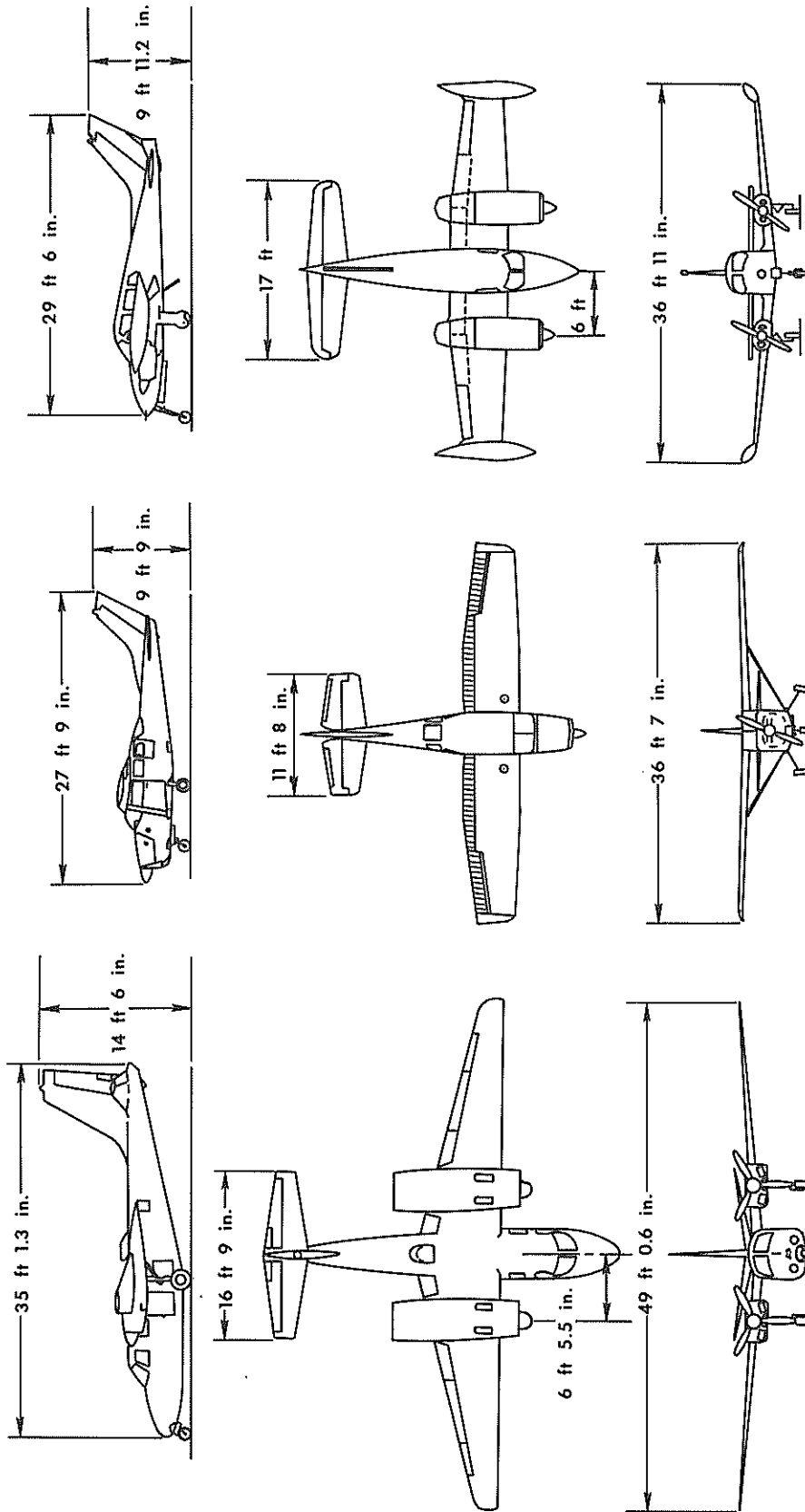

(a)

Figure 1.— Three-view drawing of airplanes tested.

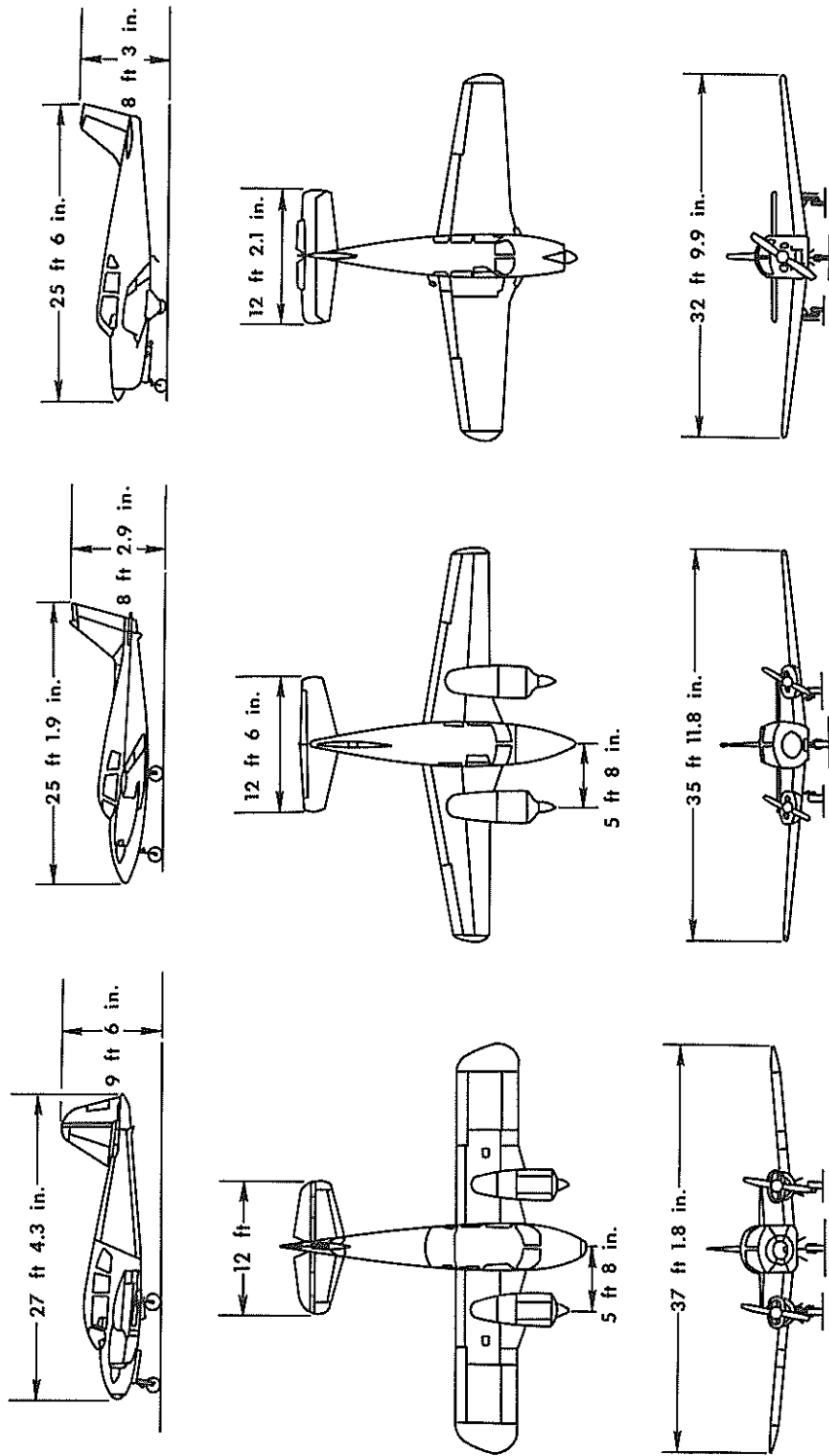

(b)

Figure 1.—Continued.

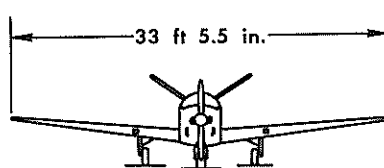
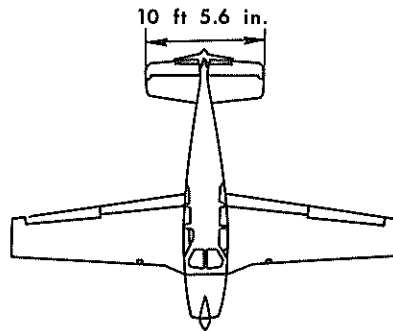
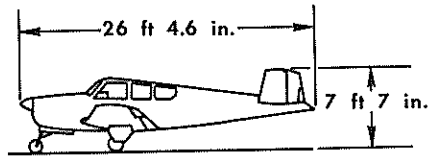

(c)

Figure 1.— Concluded.

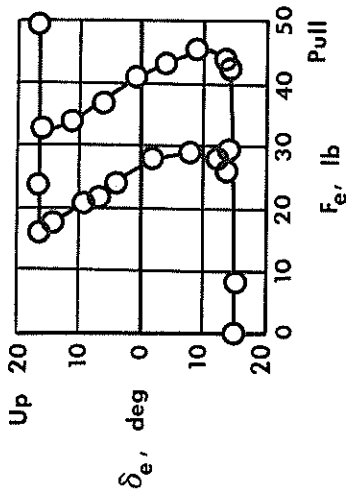
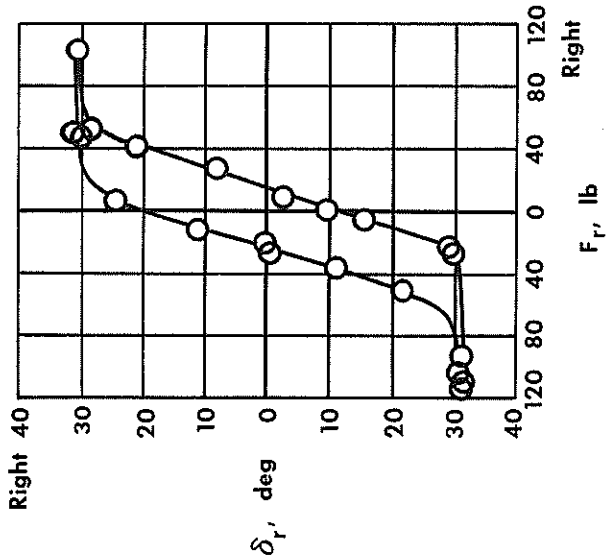
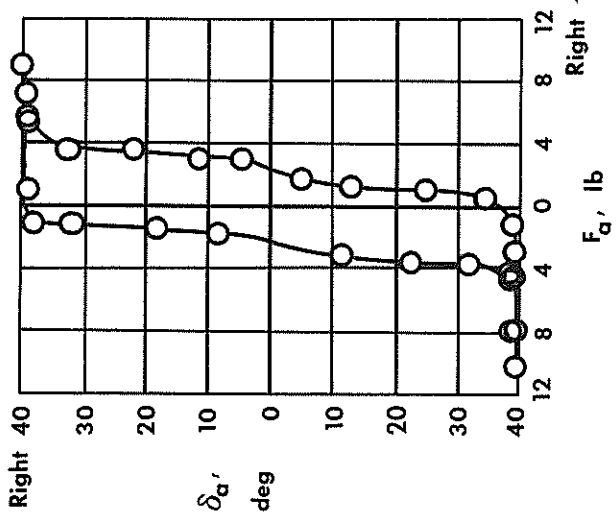

(a) Representative friction characteristics.

Aileron, lb	Rudder, lb	Elevator, lb
±4	±10	±4
±2	±20	±9
±2.5	±20	±7
±1	±43	±4
±2	±10	±5
±2	±18	±6

(b) Breakout forces (six airplanes).

Figure 2.— Static control-system characteristics.

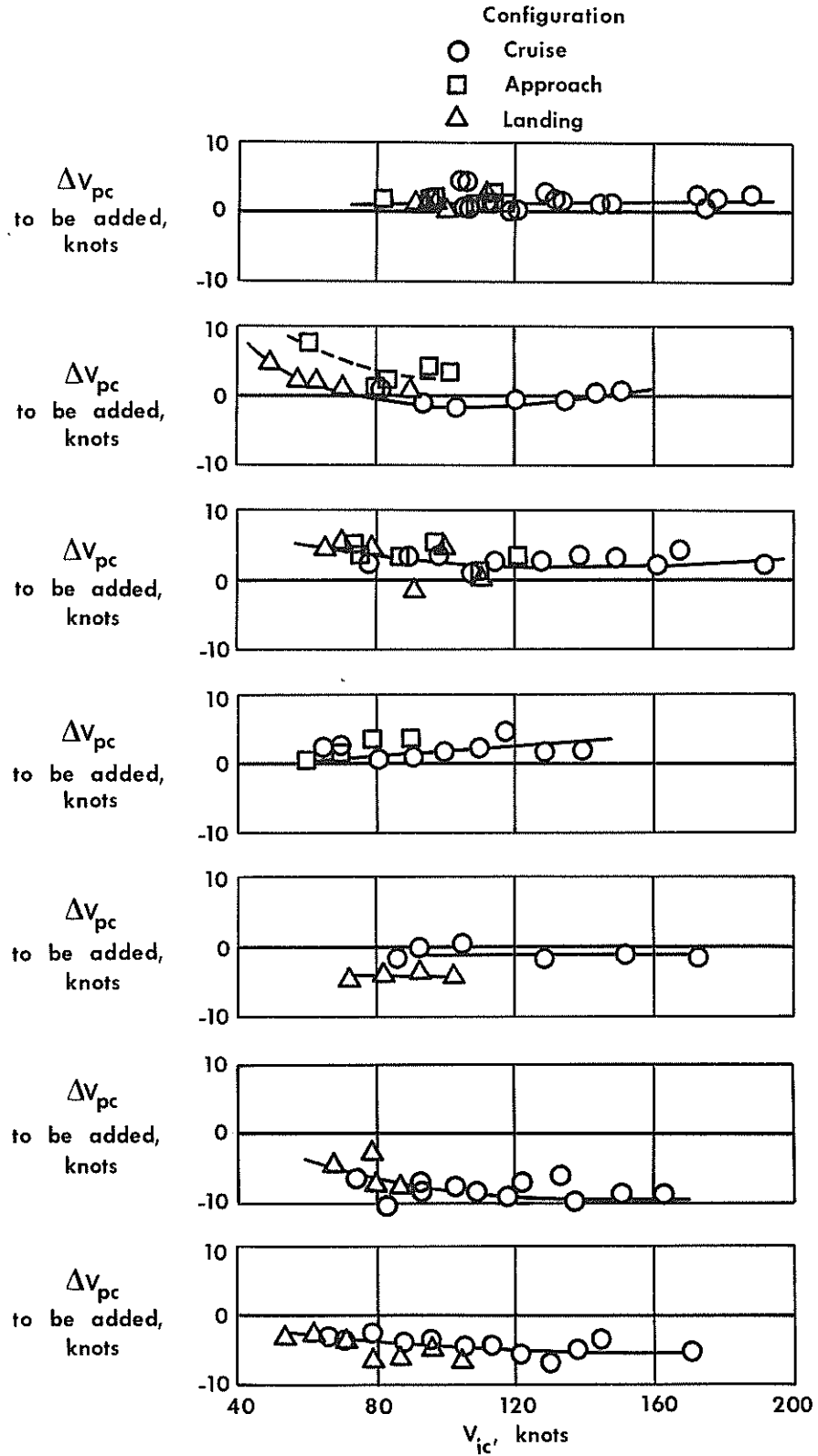
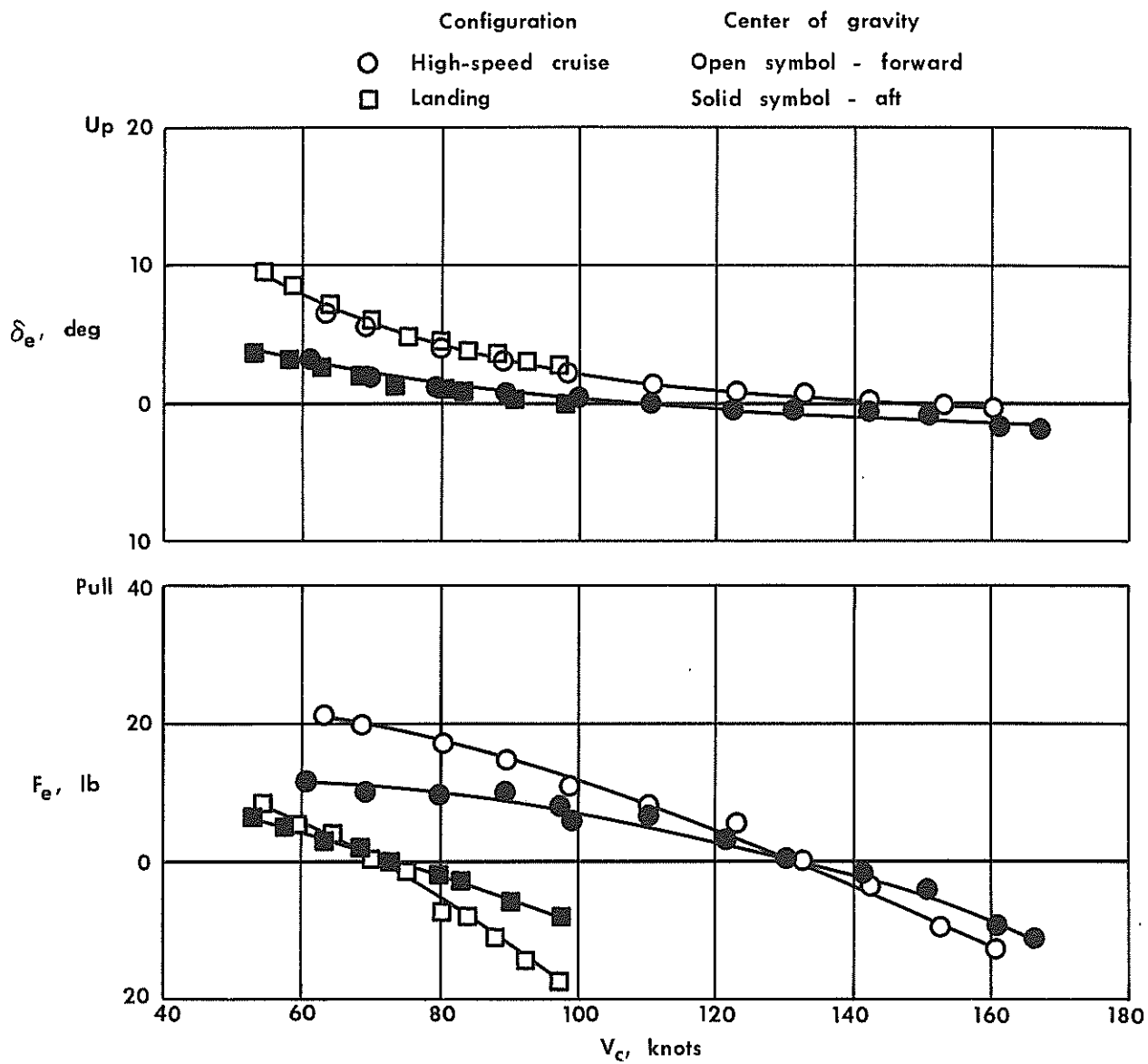
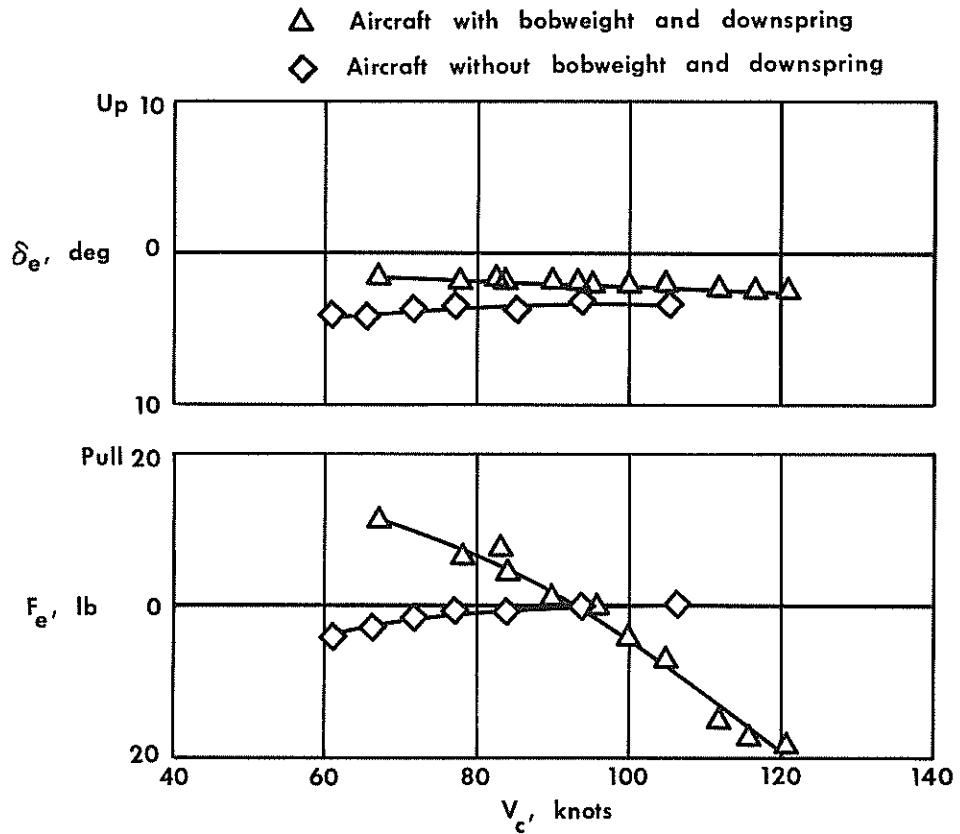

Figure 3.— Airspeed position-error calibration for all airplanes tested.



(a) Example of satisfactory gradients.

Figure 4.— Static longitudinal stability.



(b) Two examples of marginal gradients.
Aft center of gravity; approach configuration.

Figure 4.- Concluded.

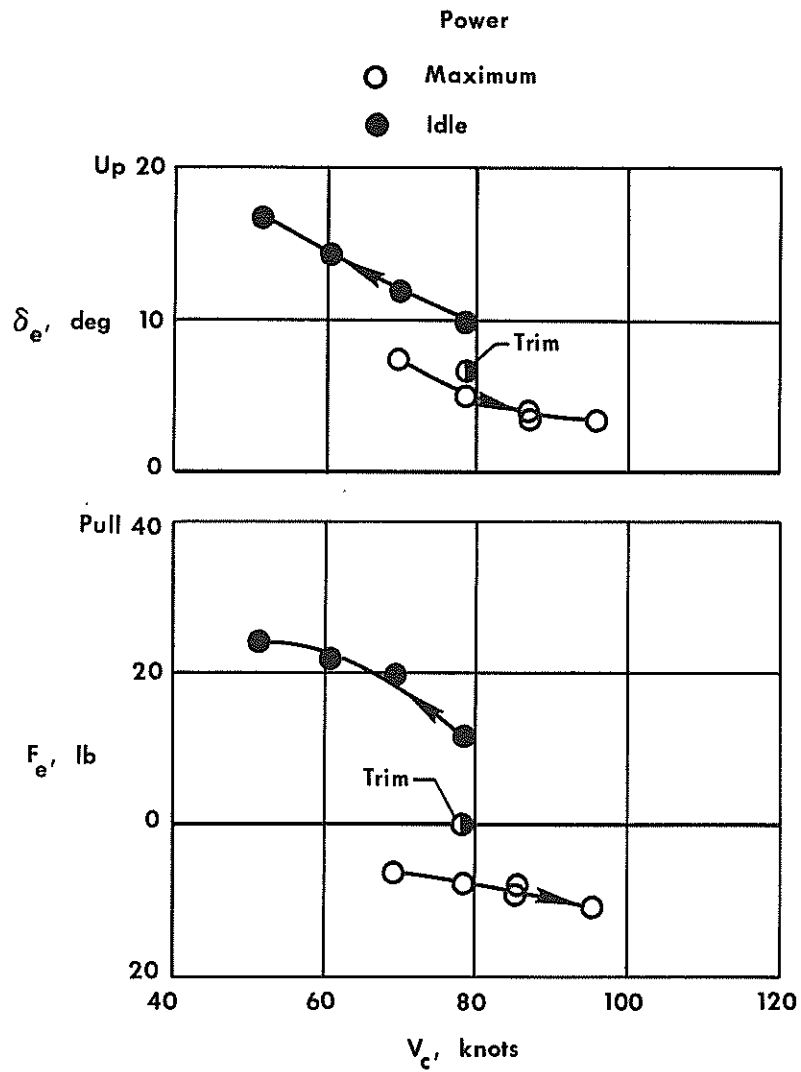
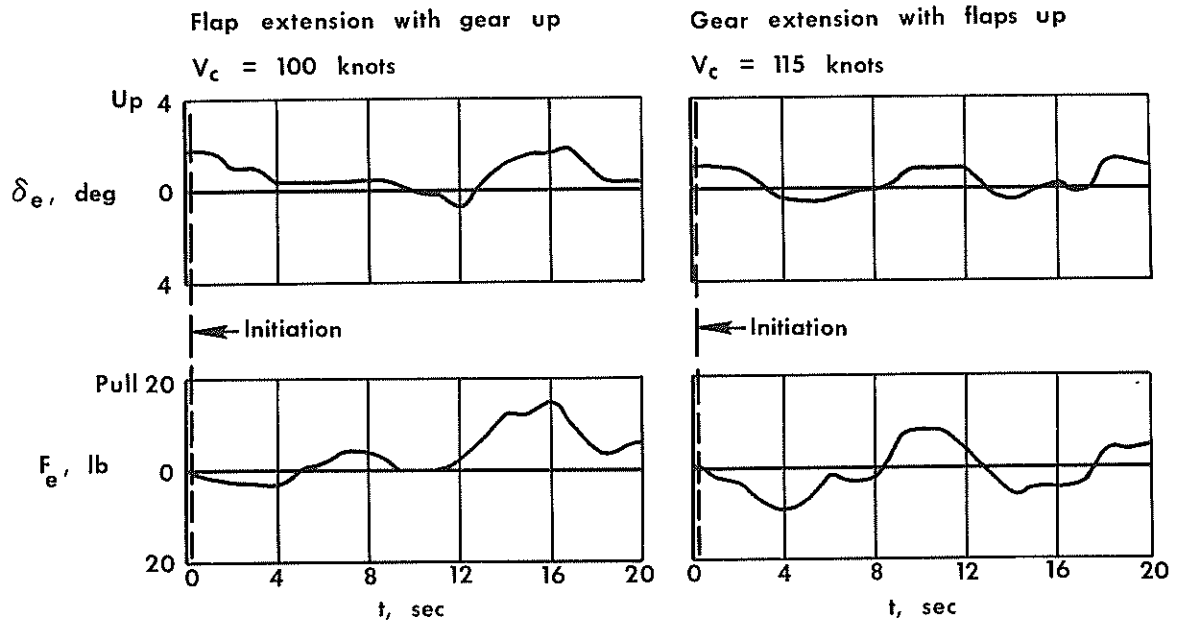
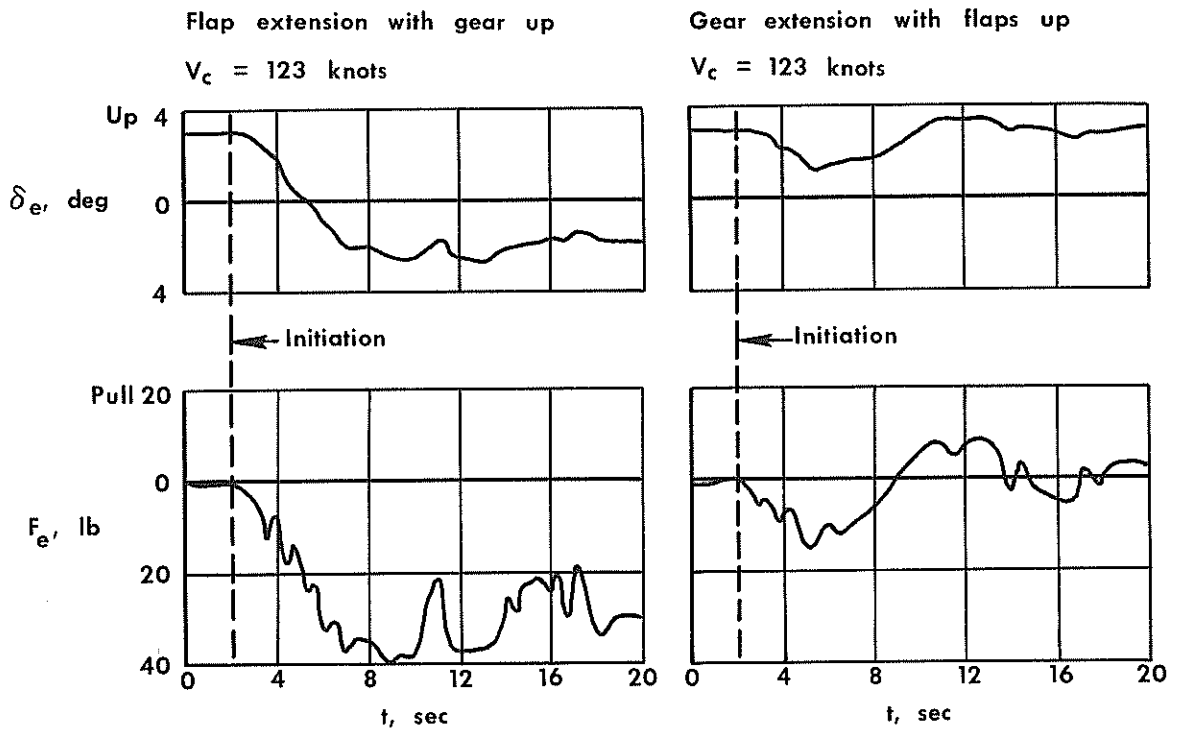

Figure 5.— Effect of power on the static longitudinal stability.
Landing configuration; forward center of gravity.



(a) Example of satisfactory trim changes.



(b) Example of unsatisfactory trim changes.

Figure 6.— Longitudinal trim changes associated with flap and gear extension at constant airspeed.
Forward center of gravity.

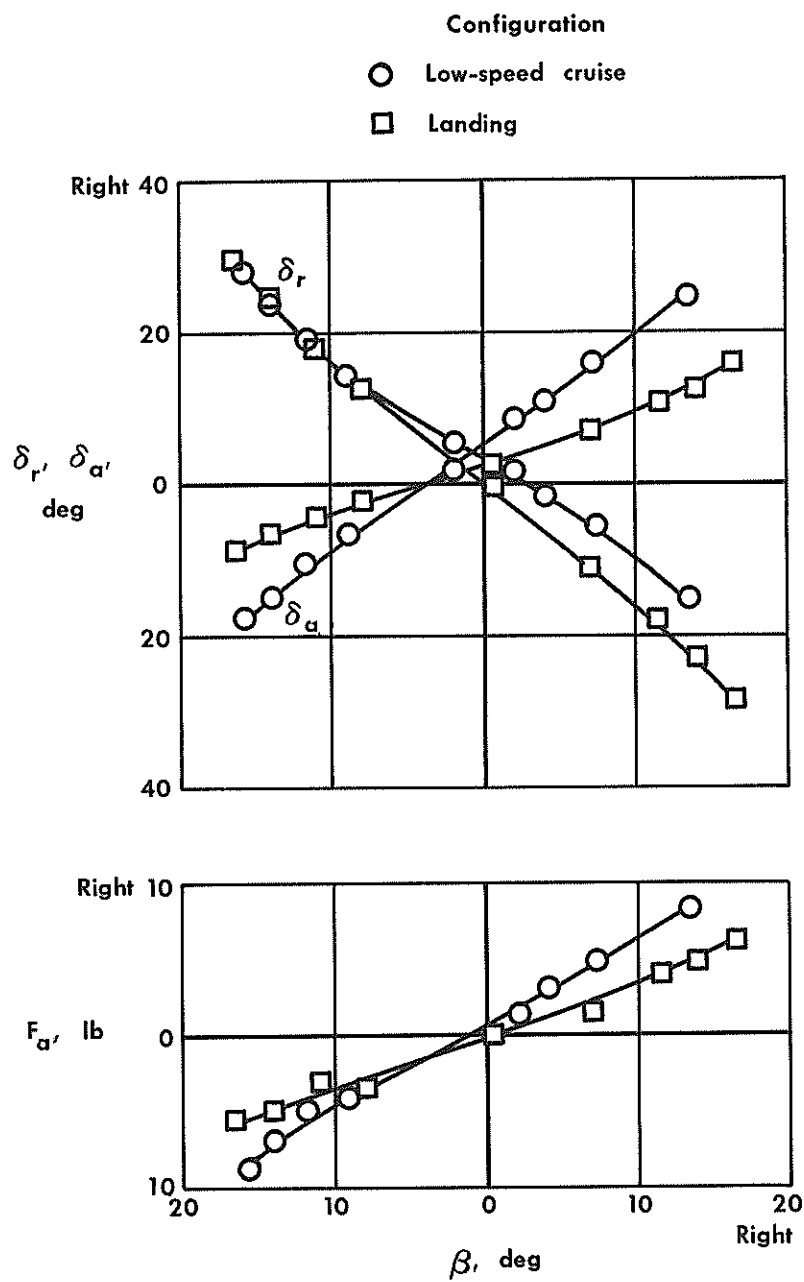

(a) Effect of configuration. $V_c = 89$ knots.

Figure 7.— Static lateral-directional stability in constant-heading sideslips.

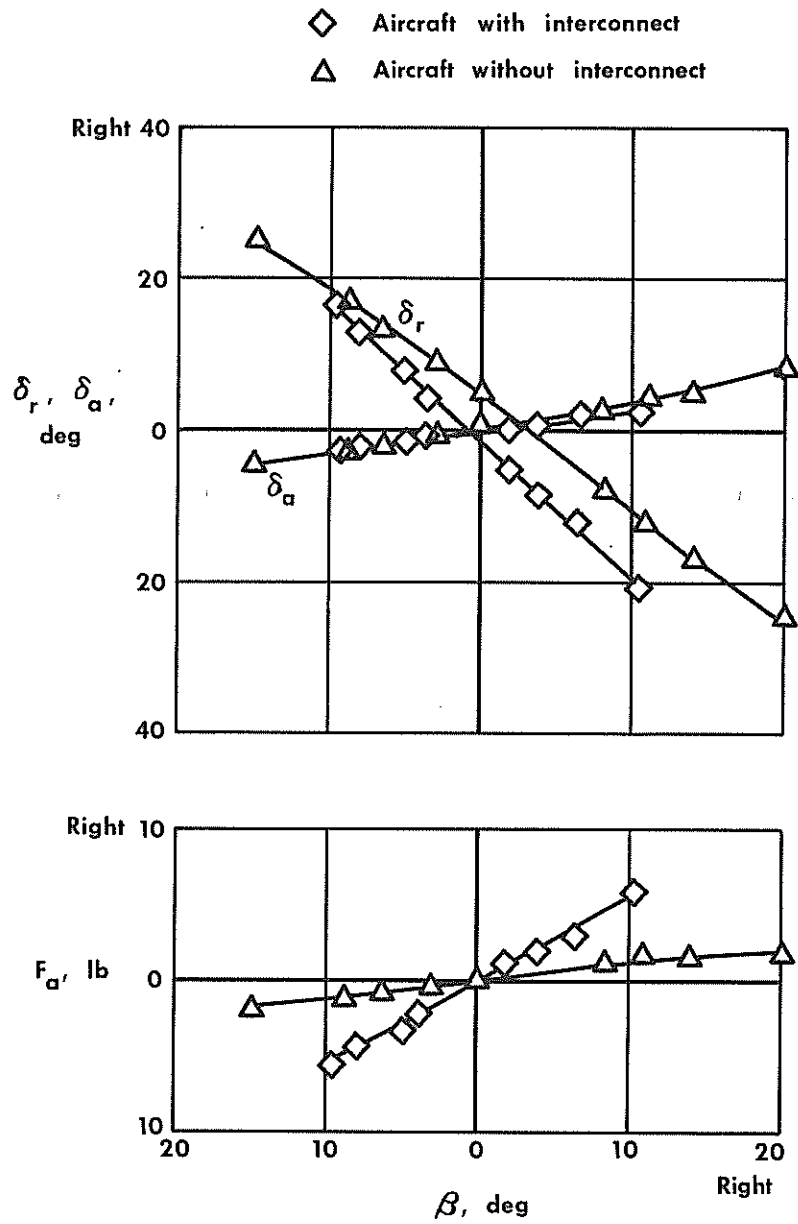

(b) Effect of rudder-aileron interconnect. Landing configuration;
 $V_c = 73$ knots.

Figure 7.— Concluded.

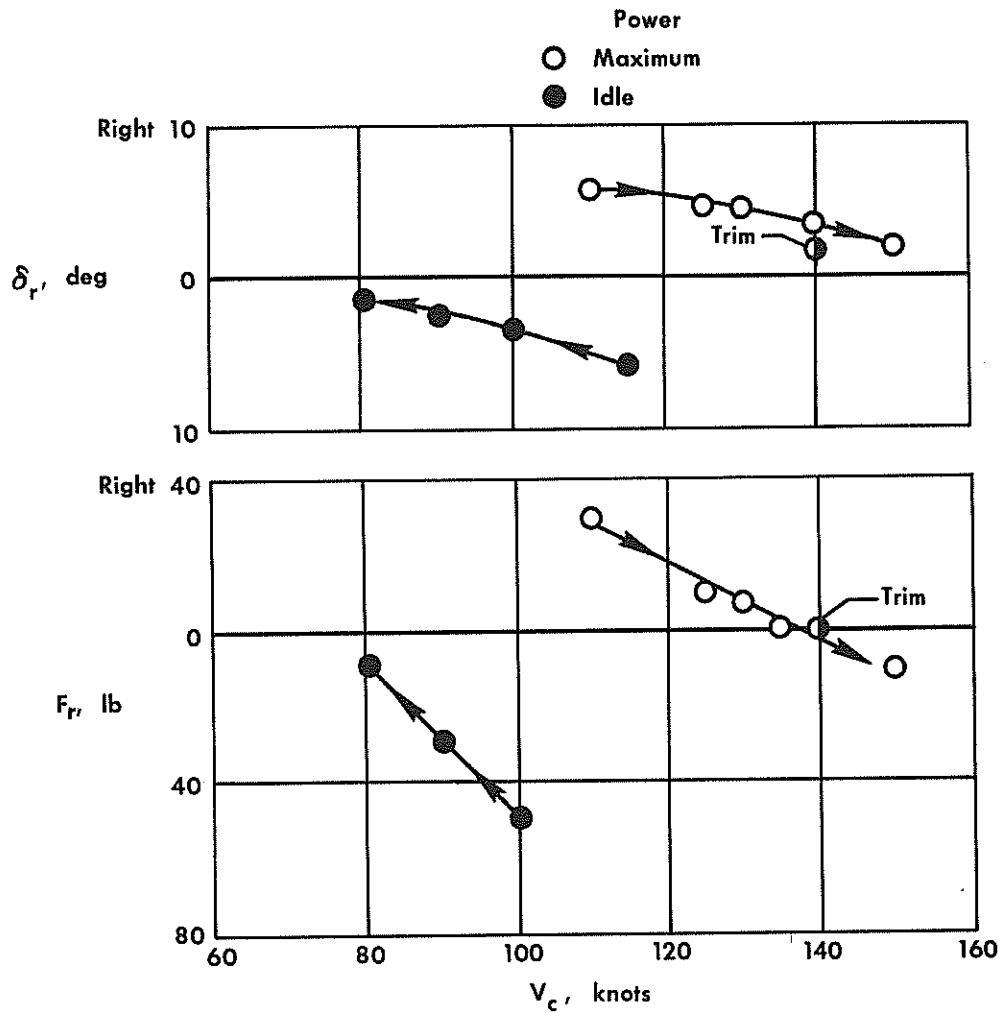
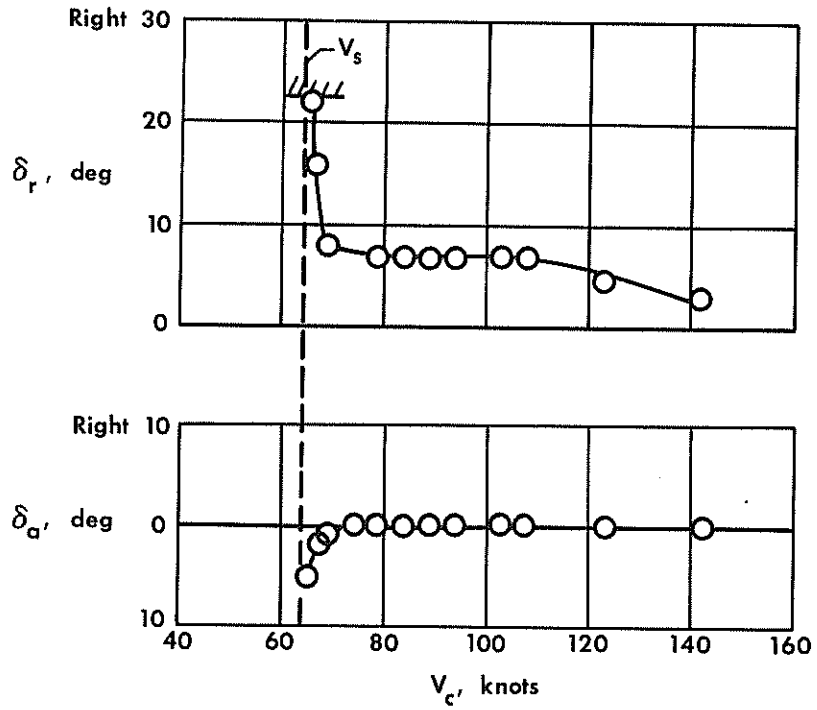
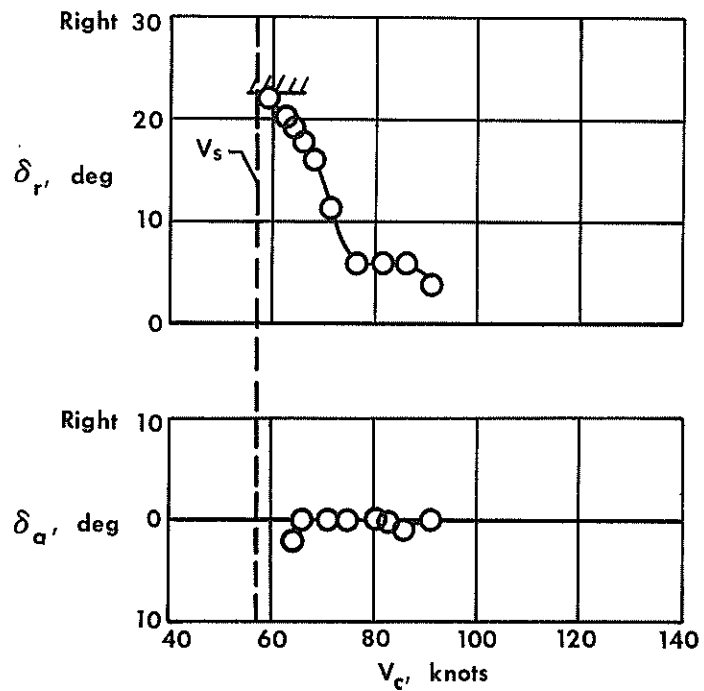

Figure 8.— Effect of power on static directional trim changes with speed.
 Constant heading; cruise configuration; forward center of gravity.



(a) Cruise configuration.



(b) Landing configuration.

Figure 9.— Unsatisfactory lateral-directional trim changes with airspeed. Constant heading; maximum power on both engines.

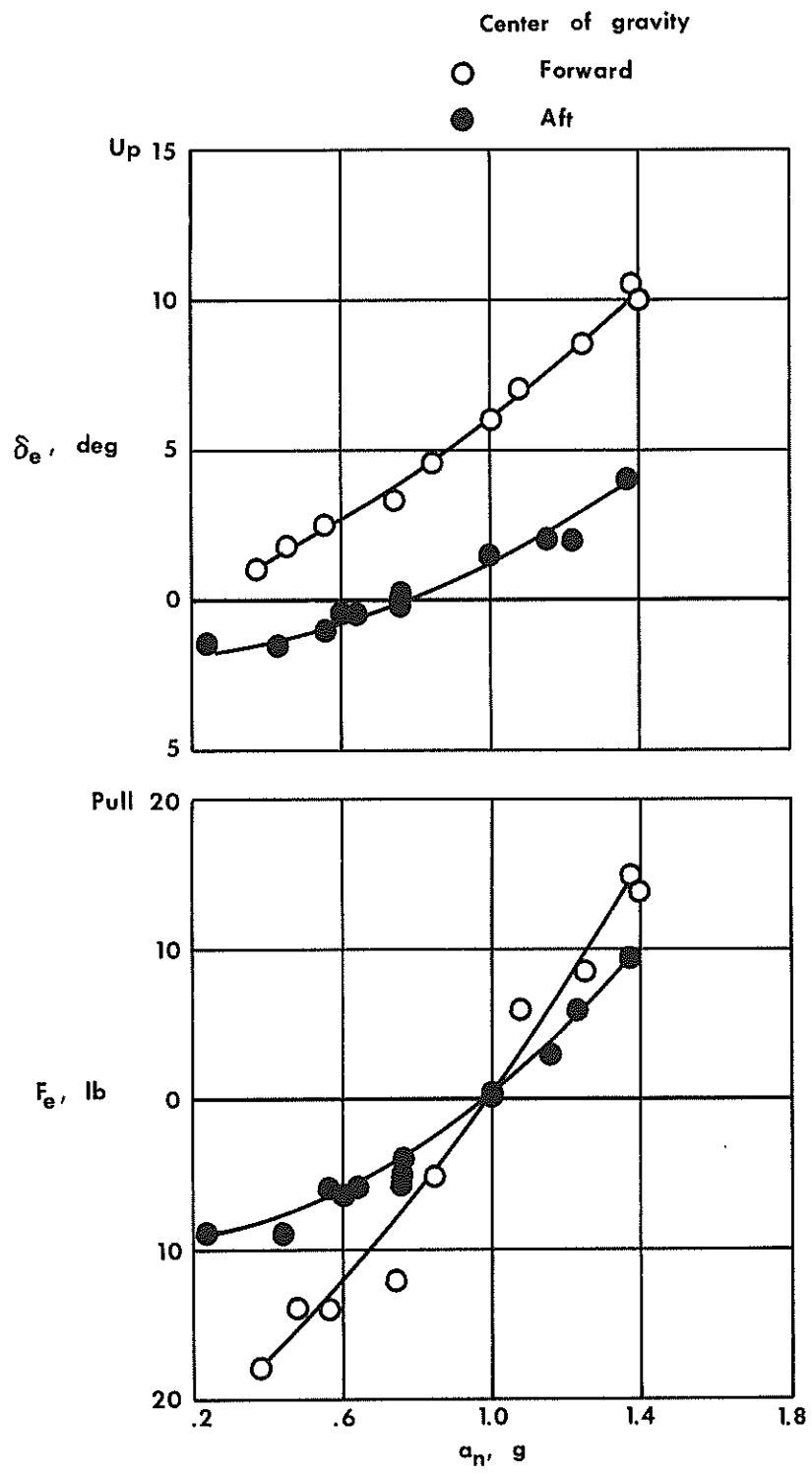

Figure 10.— Representative longitudinal maneuverability gradients.
Landing configuration; $V_c = 70$ knots.

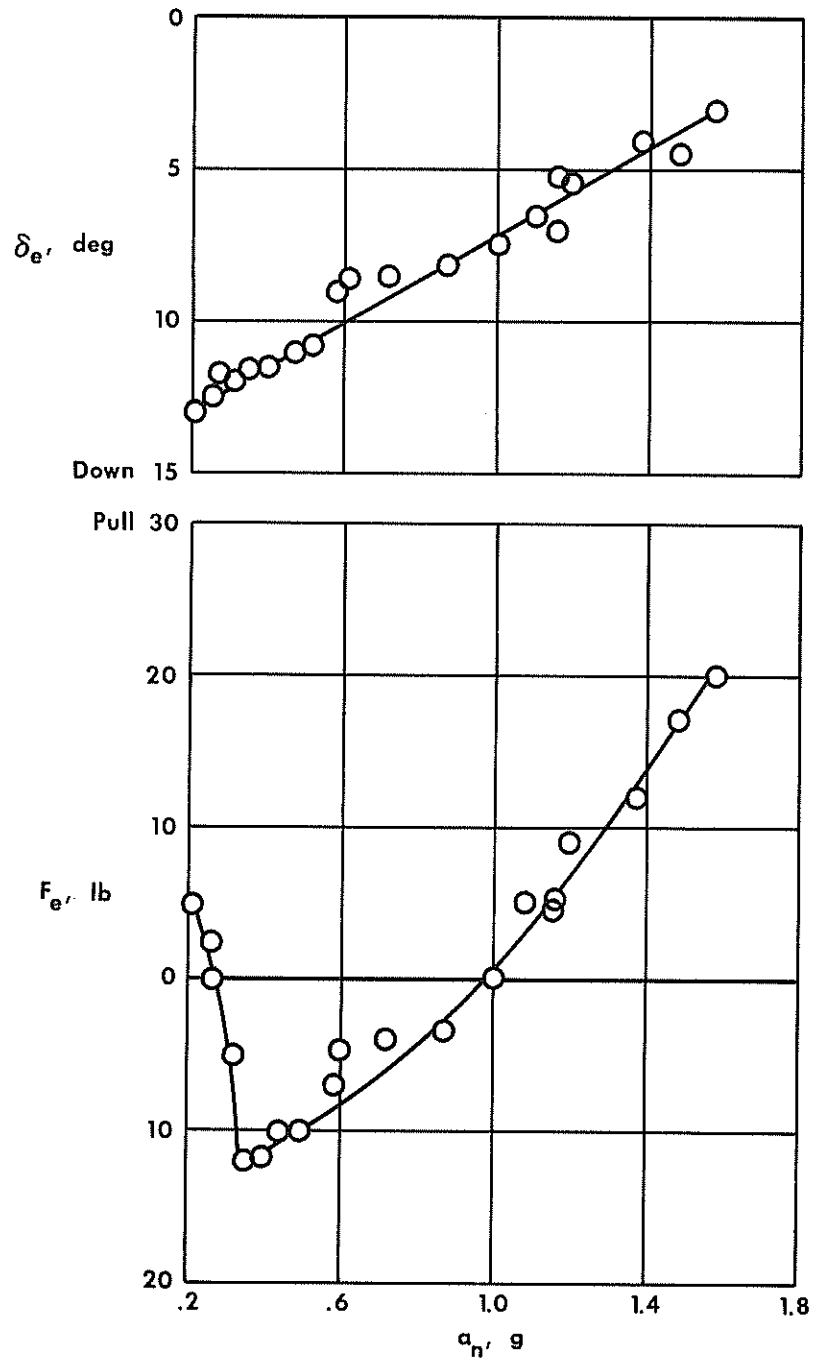

Figure 11.— Example of elevator force reversal, landing configuration; aft center of gravity; $V_0 = 72$ knots.

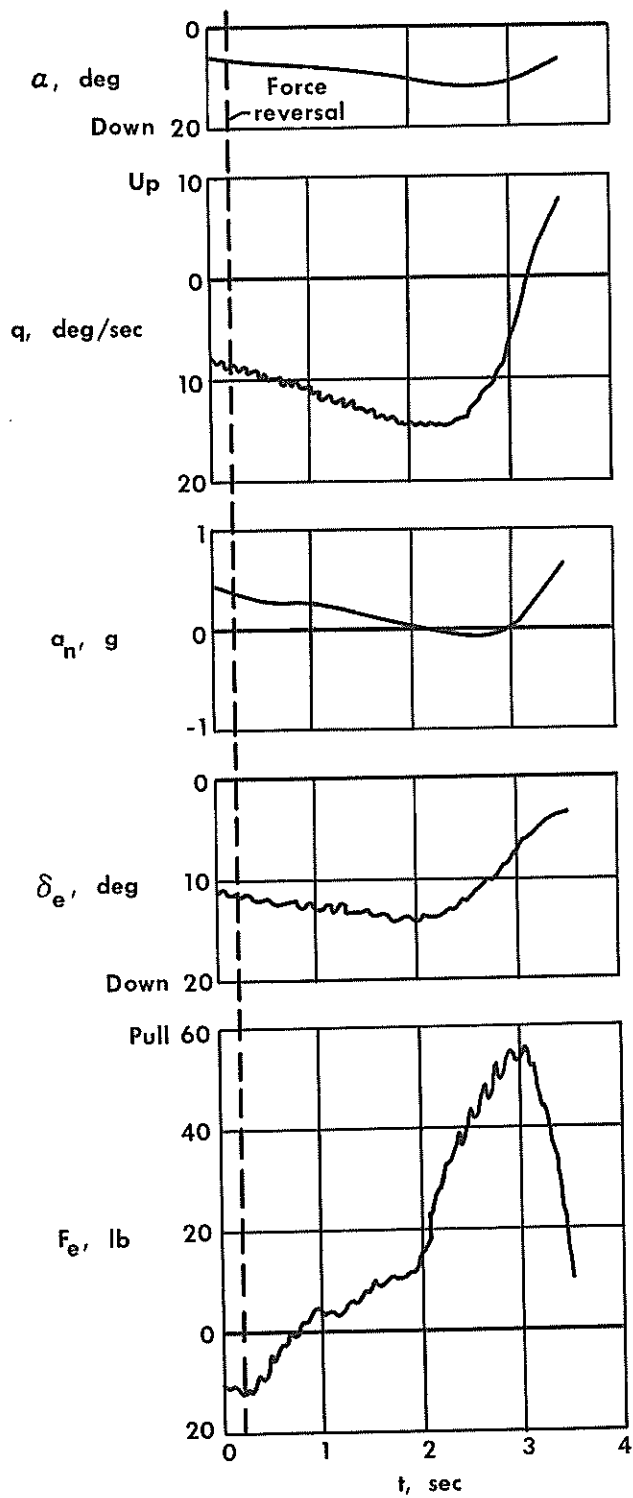

Figure 12.— Time history of pertinent longitudinal parameters during force reversal shown in figure 11. Landing configuration; aft center of gravity; $V_C = 72$ knots.

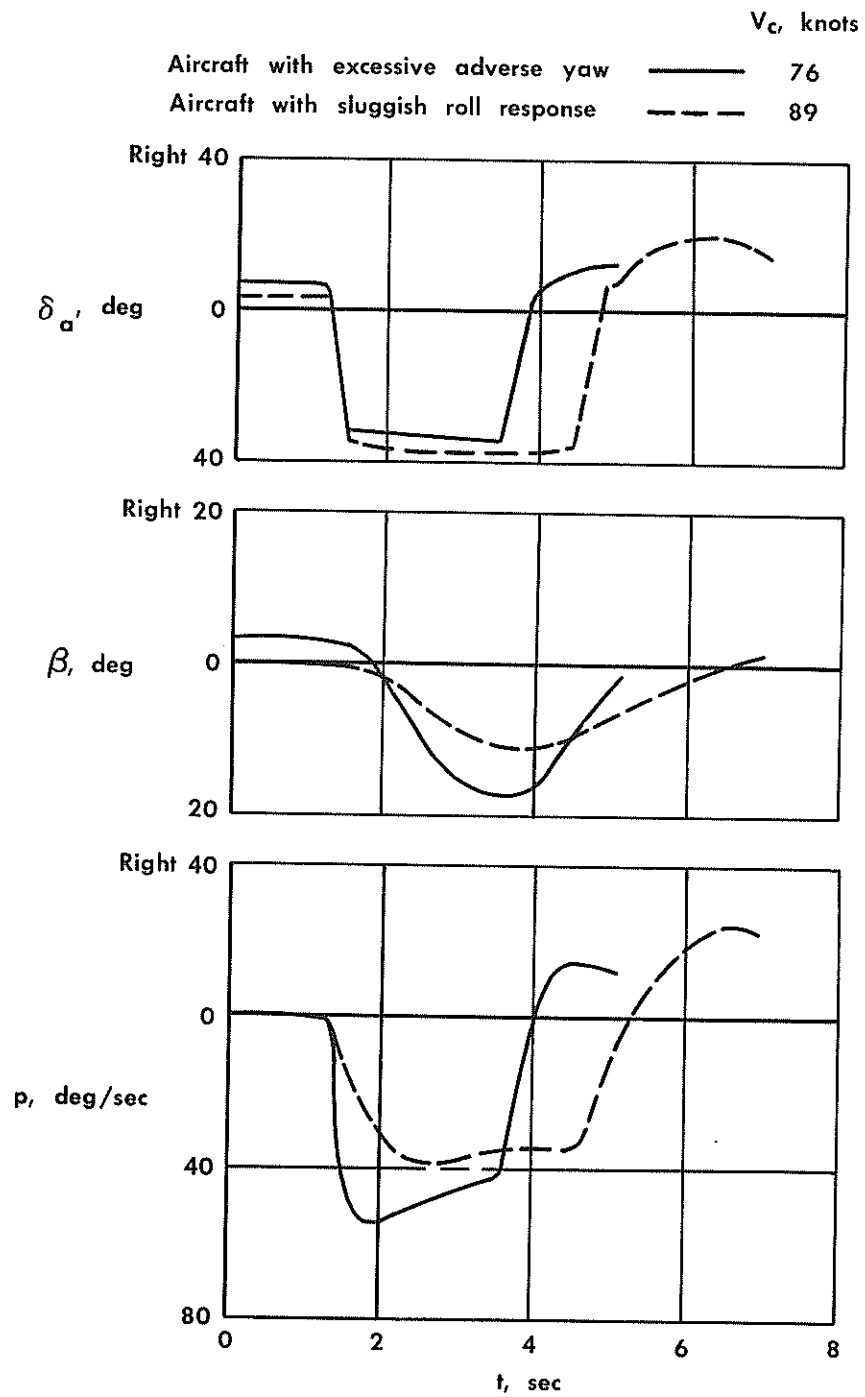
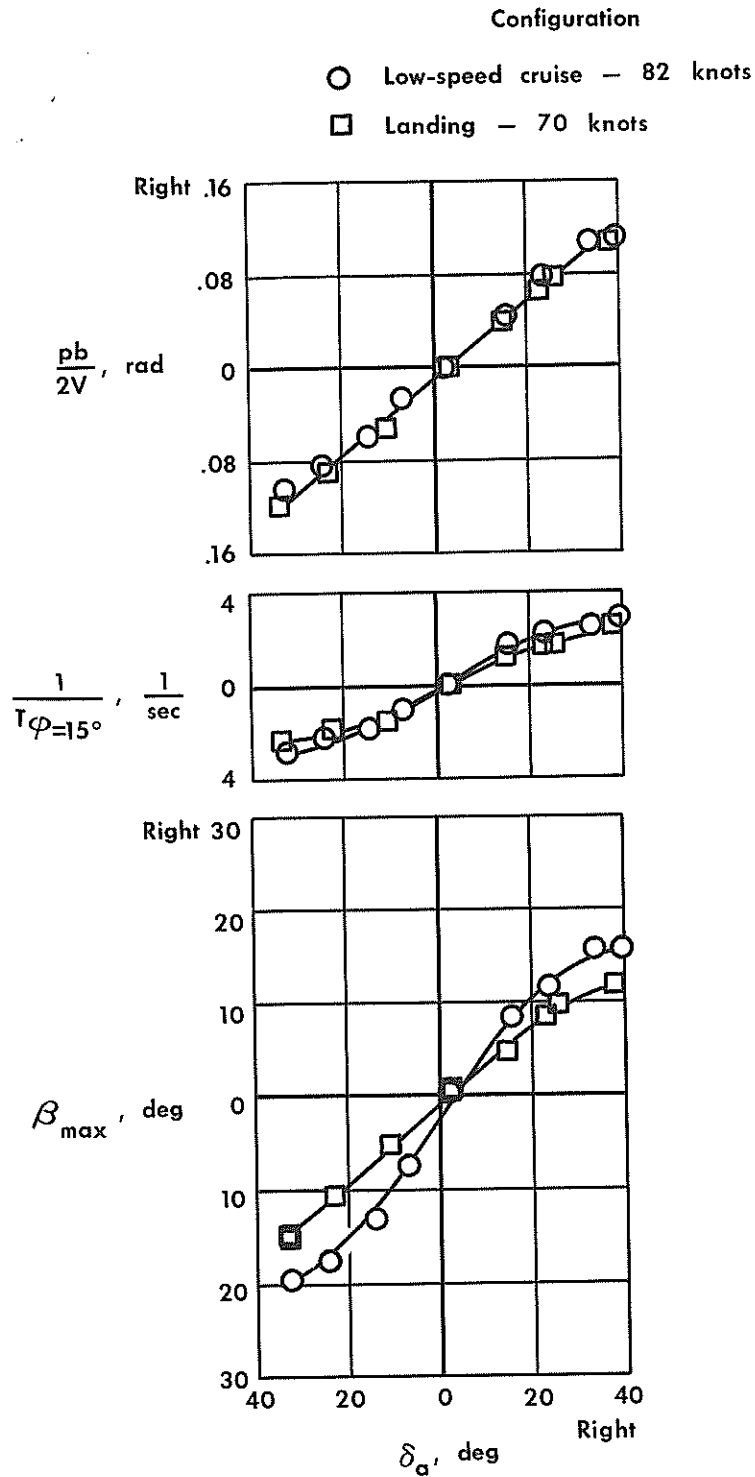
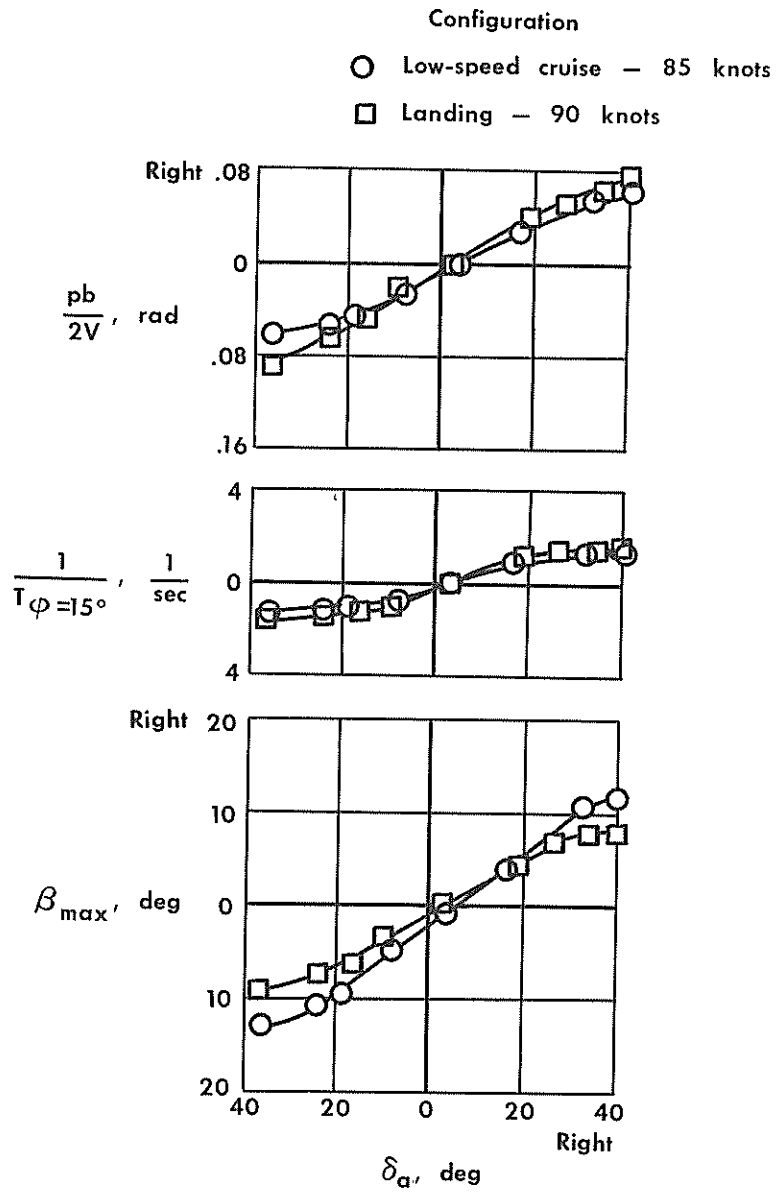

Figure 13.— Time histories of abrupt rudder-fixed aileron rolls. Approach configuration.



(a) Aircraft of figure 13 with excessive adverse yaw.

Figure 14.— Lateral maneuverability in abrupt rudder-fixed aileron rolls.



(b) Aircraft of figure 13 with sluggish response.

Figure 14.— Concluded.

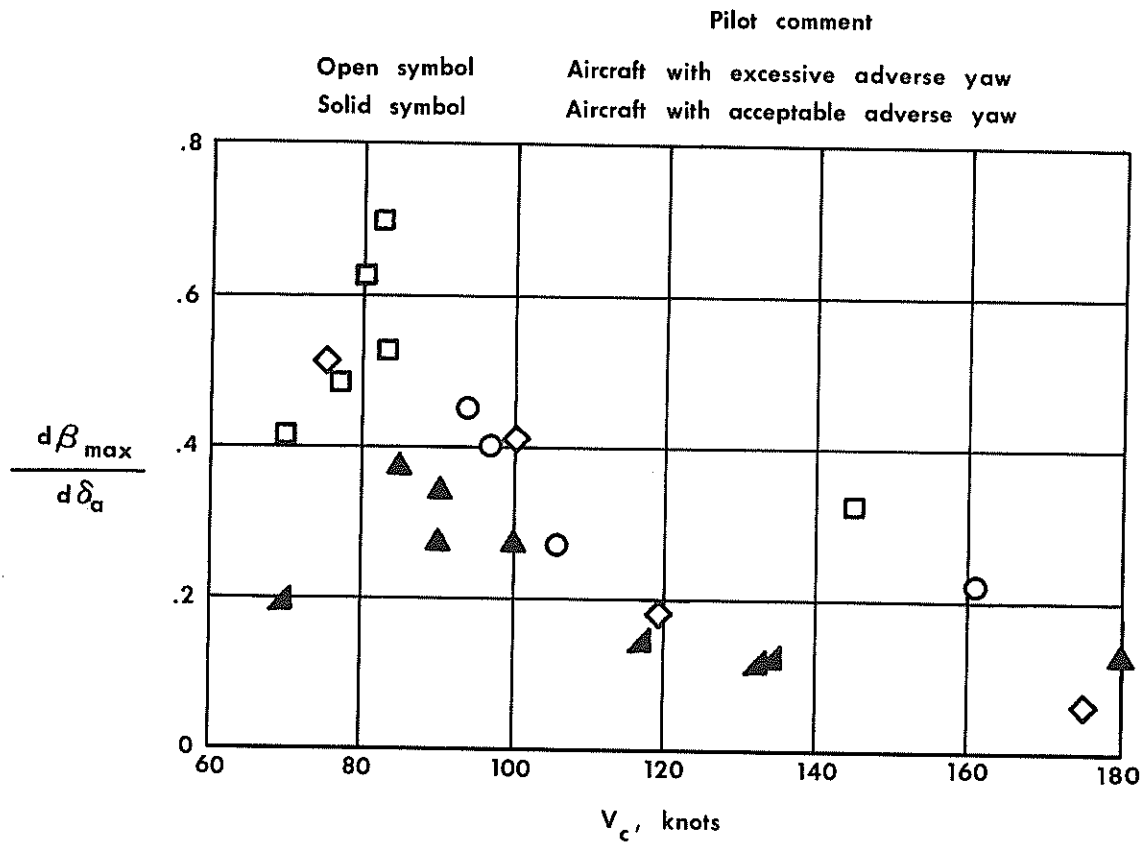

Figure 16.— Summary of adverse aileron yaw for five airplanes from abrupt rudder-fixed aileron rolls. All configurations.

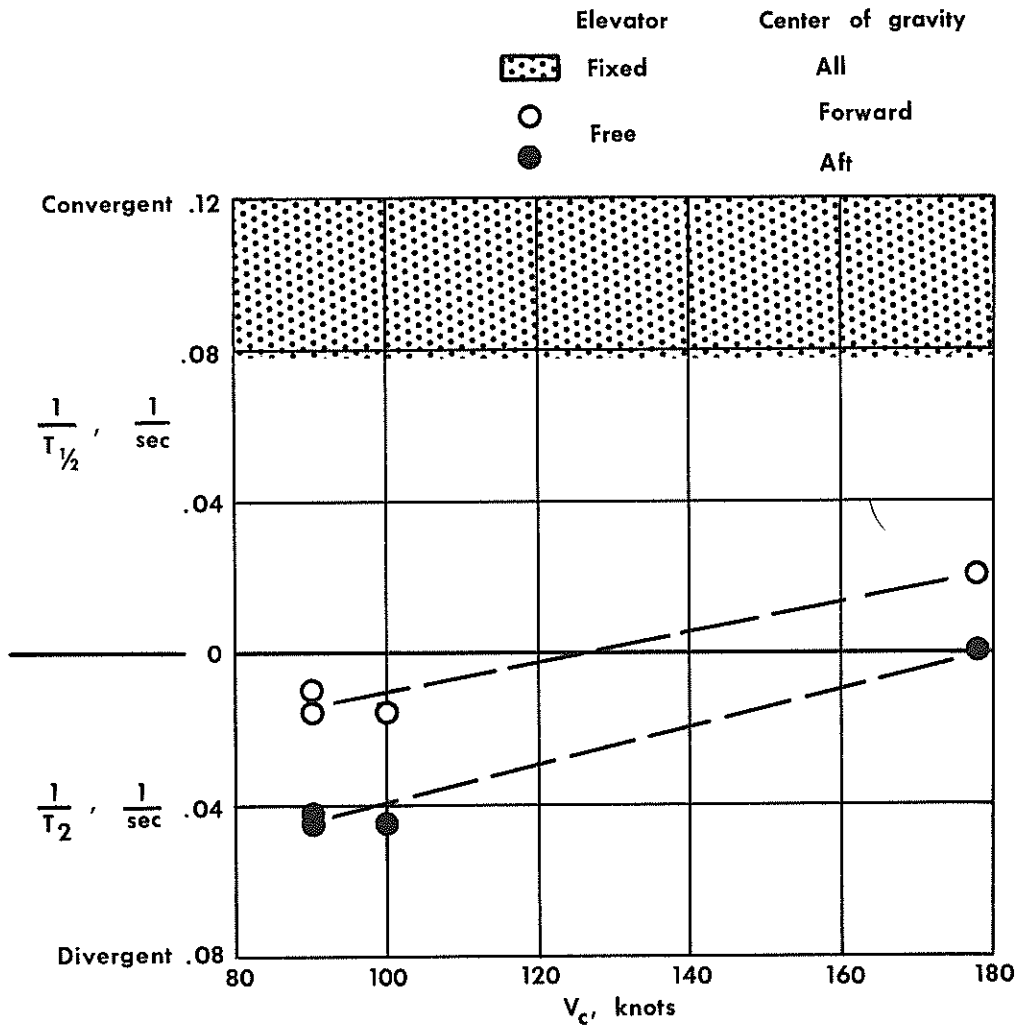
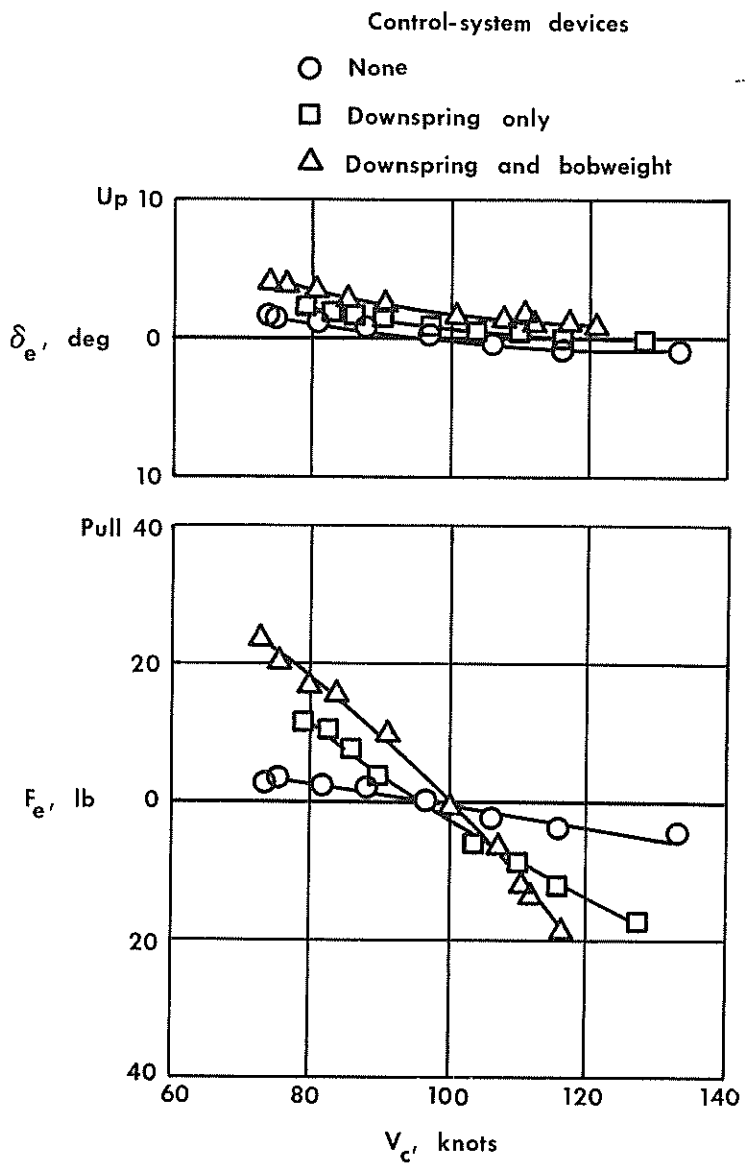

Figure 17.— Longitudinal long-period (phugoid) dynamics of the aircraft with the least damping. All configurations.



(a) Static stability.

Figure 18.— Effect of downspring and bobweight on longitudinal static and maneuvering stability. Approach configuration; mid center of gravity.

Control-system devices

- None
- Downspring only
- △ Downspring and bobweight

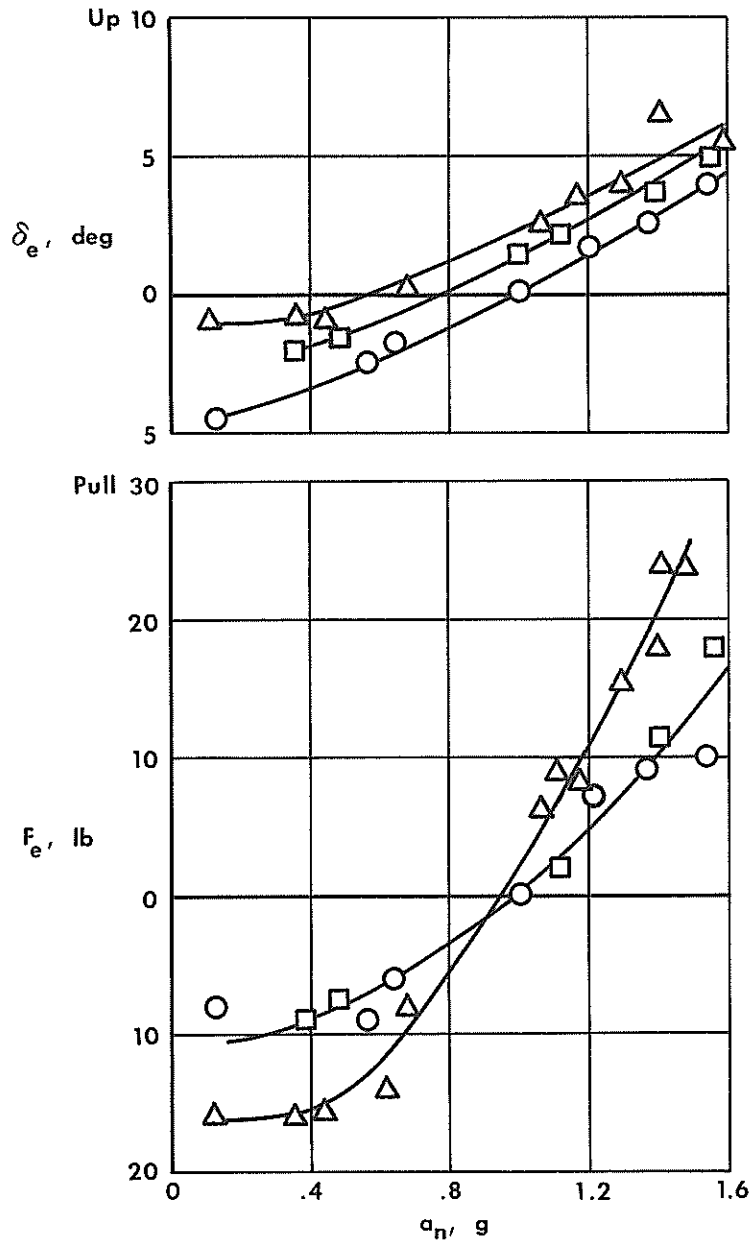

(b) Maneuvering stability. $V_e = 97$ knots.

Figure 18.- Concluded.

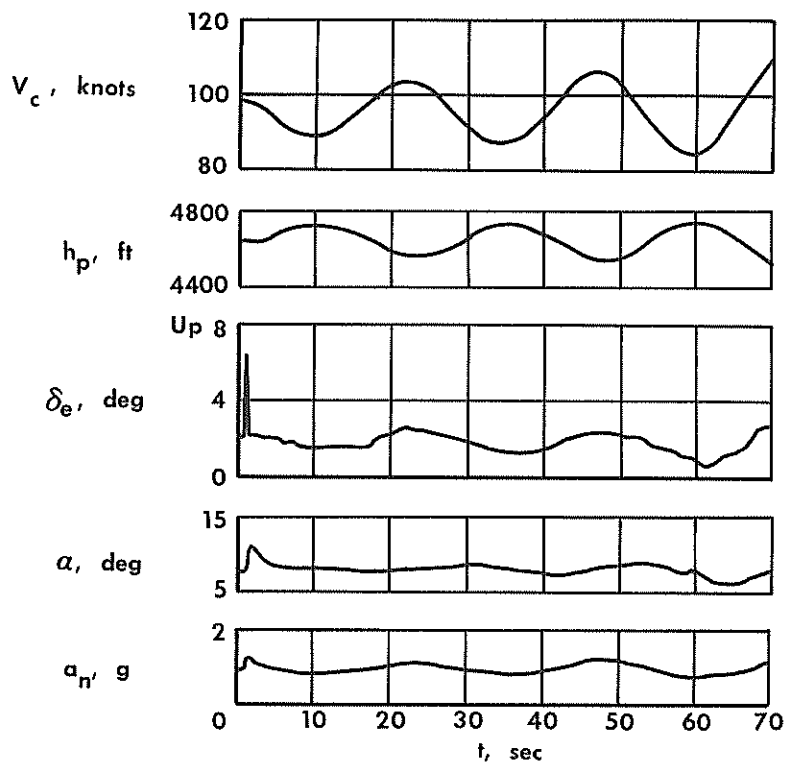

(a) With bobweight and downspring.

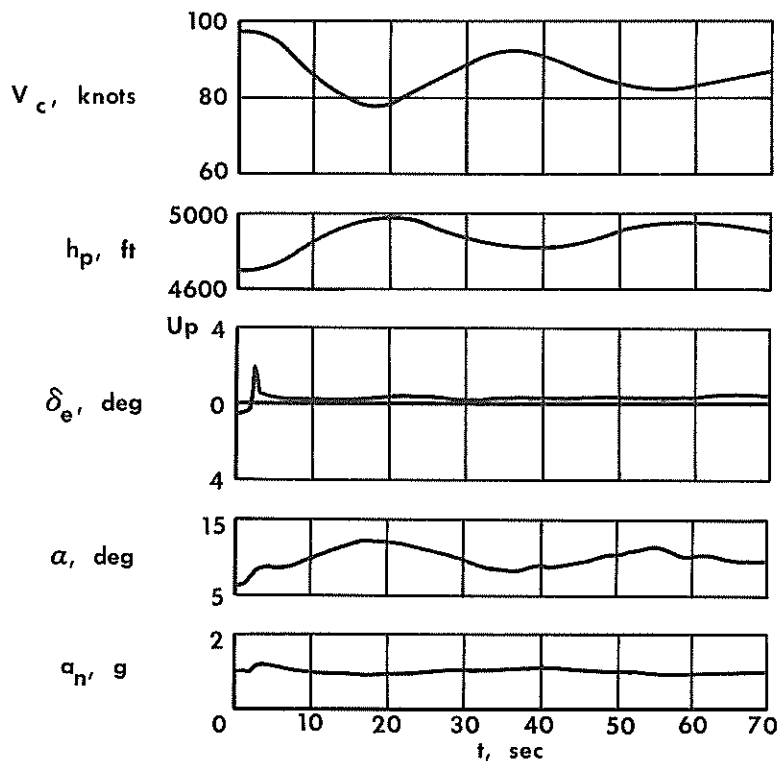

(b) Without bobweight and downspring.

Figure 19.—Time history of control-free phugoid oscillation of the aircraft of figure 18; approach configuration; mid center of gravity.

Configuration

○ Cruise

□ Approach

△ Landing

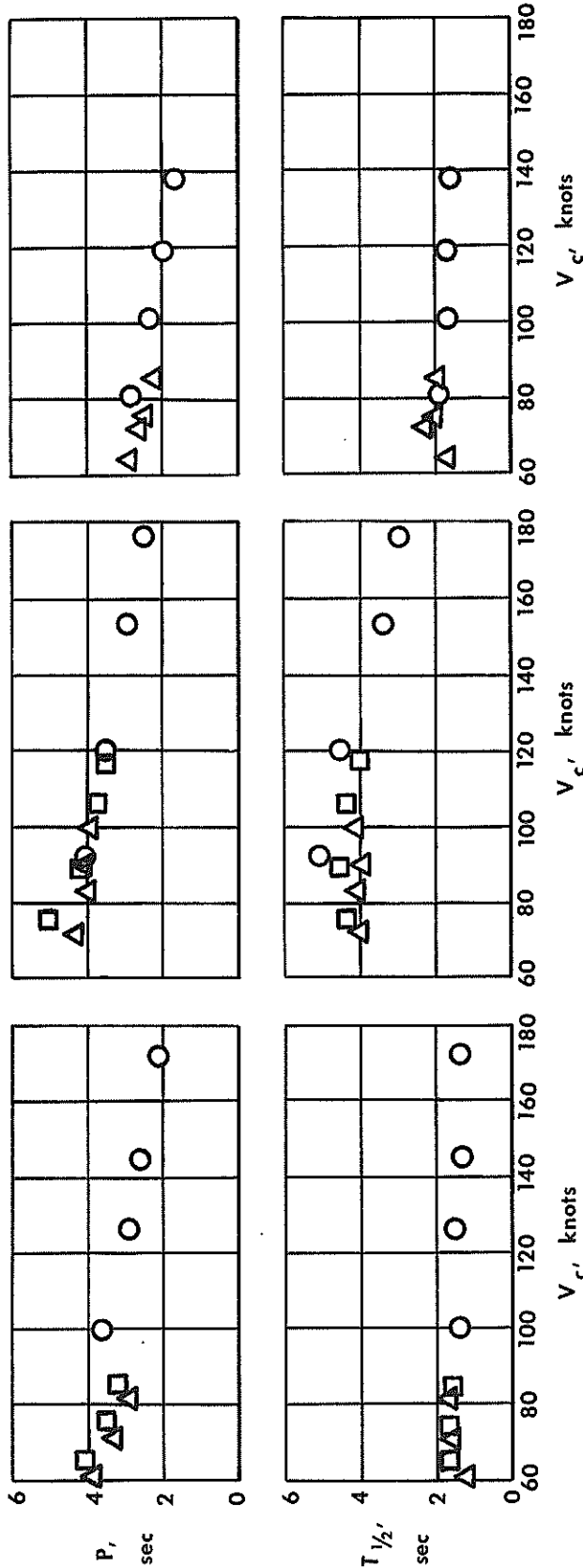

(a) Aircraft with most satisfactory characteristics.

(b) Aircraft with lowest damping.

(c) Aircraft with highest frequency.

Figure 20. — Dynamic lateral-directional stability (Dutch roll).

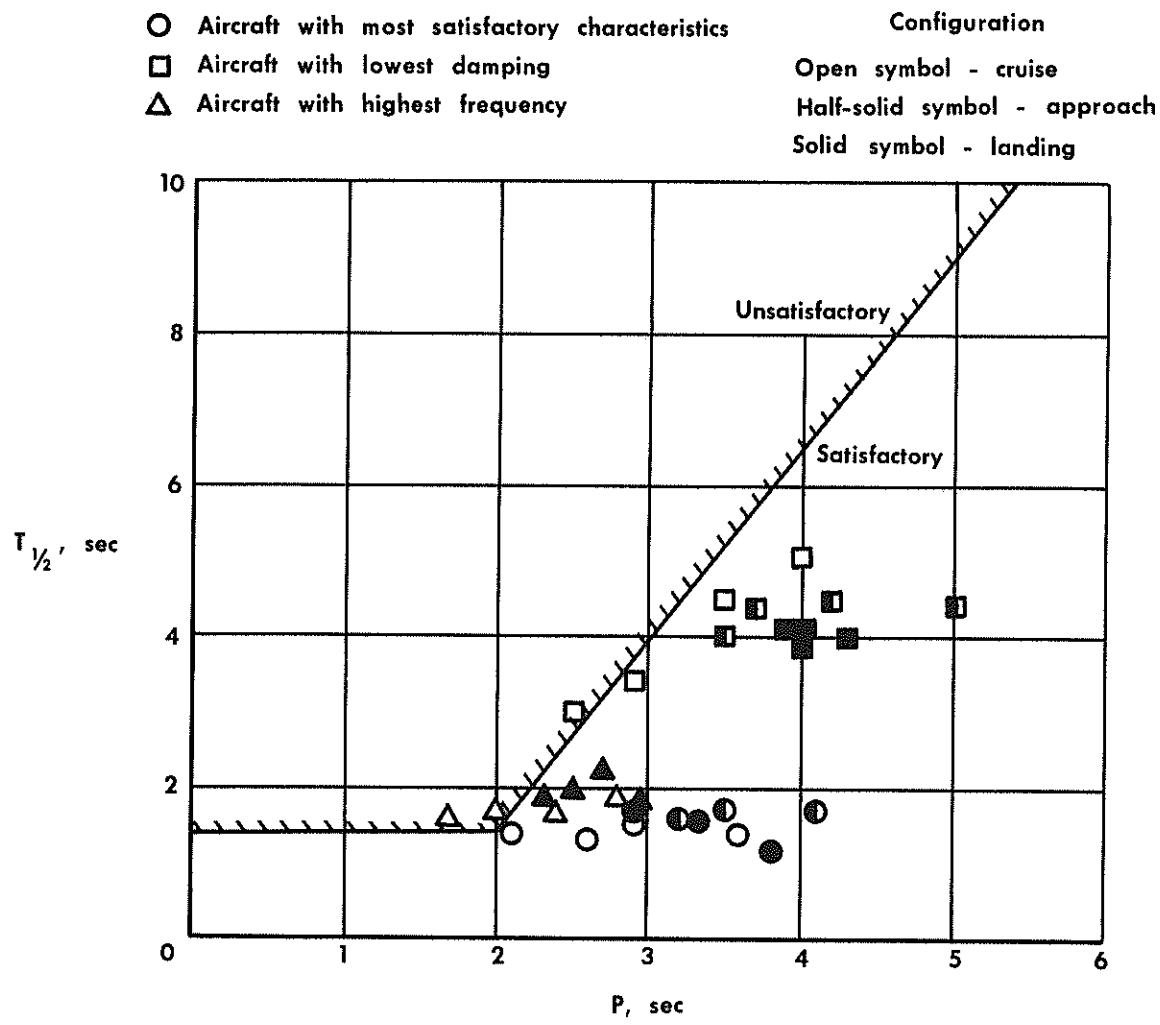

(a) Predecessor of reference 6 (U. S. Air Force Specification 1815-B).

Figure 21.- Dutch-roll criteria.

- Aircraft with most satisfactory characteristics
- Aircraft with lowest damping
- △ Aircraft with highest frequency

- Configuration
- Open symbol - cruise
 - Half-solid symbol - approach
 - Solid symbol - landing

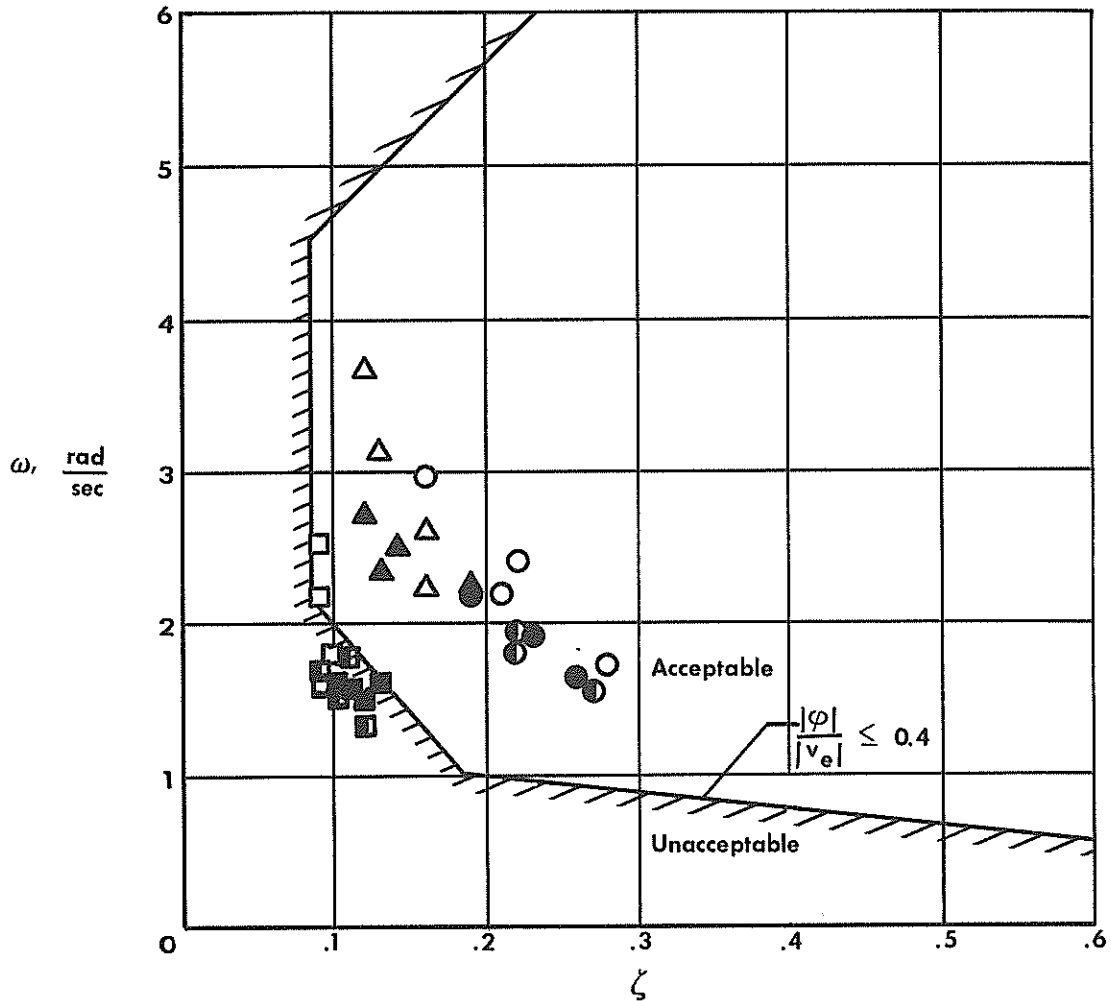

(b) Proposed amendment to reference 6 (ref. 12).

Figure 21.— Concluded.

Reference 6 boundaries

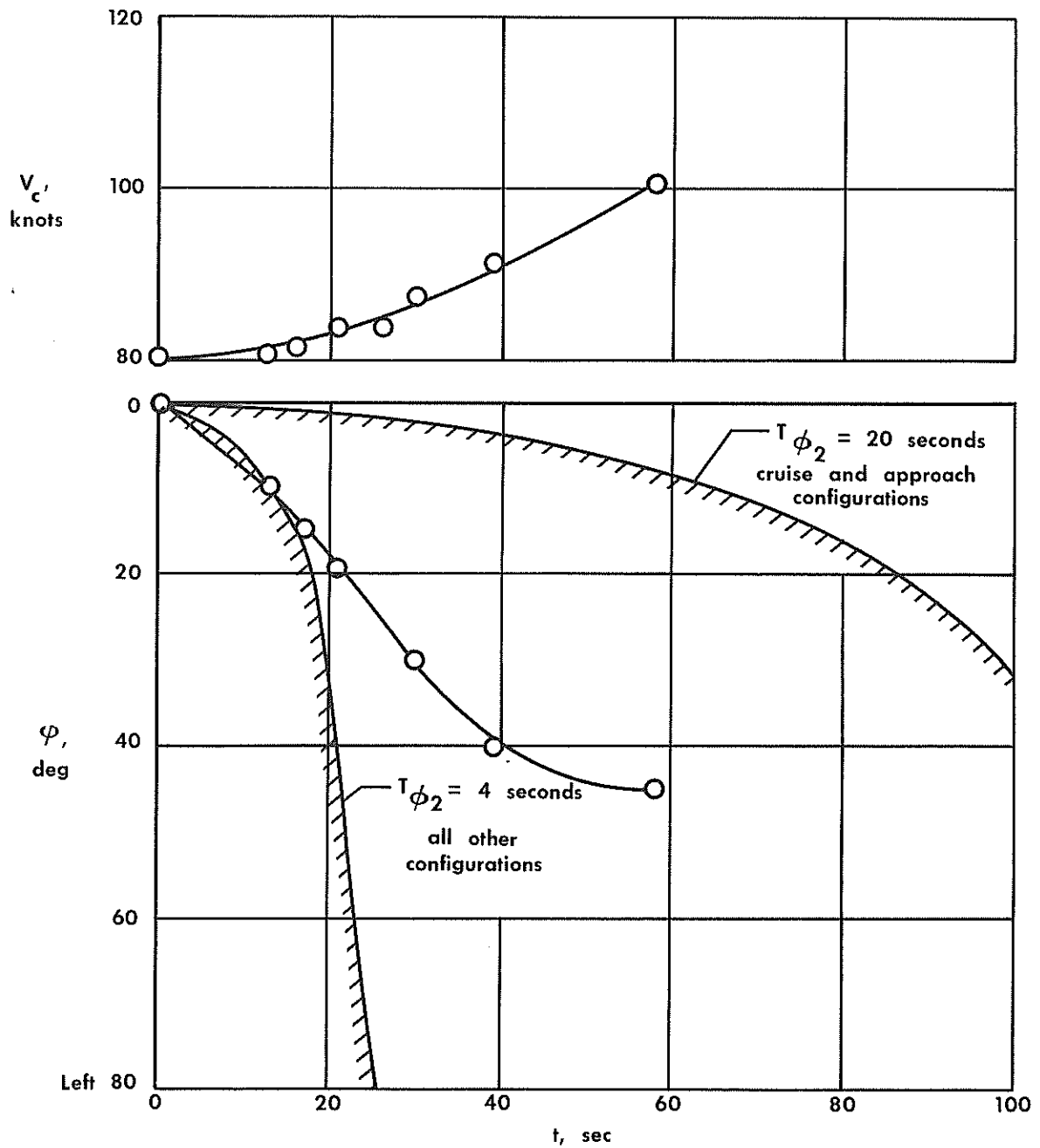

Figure 22.— Control-free spiral characteristics of an aircraft with high rates of divergence. Approach configuration.

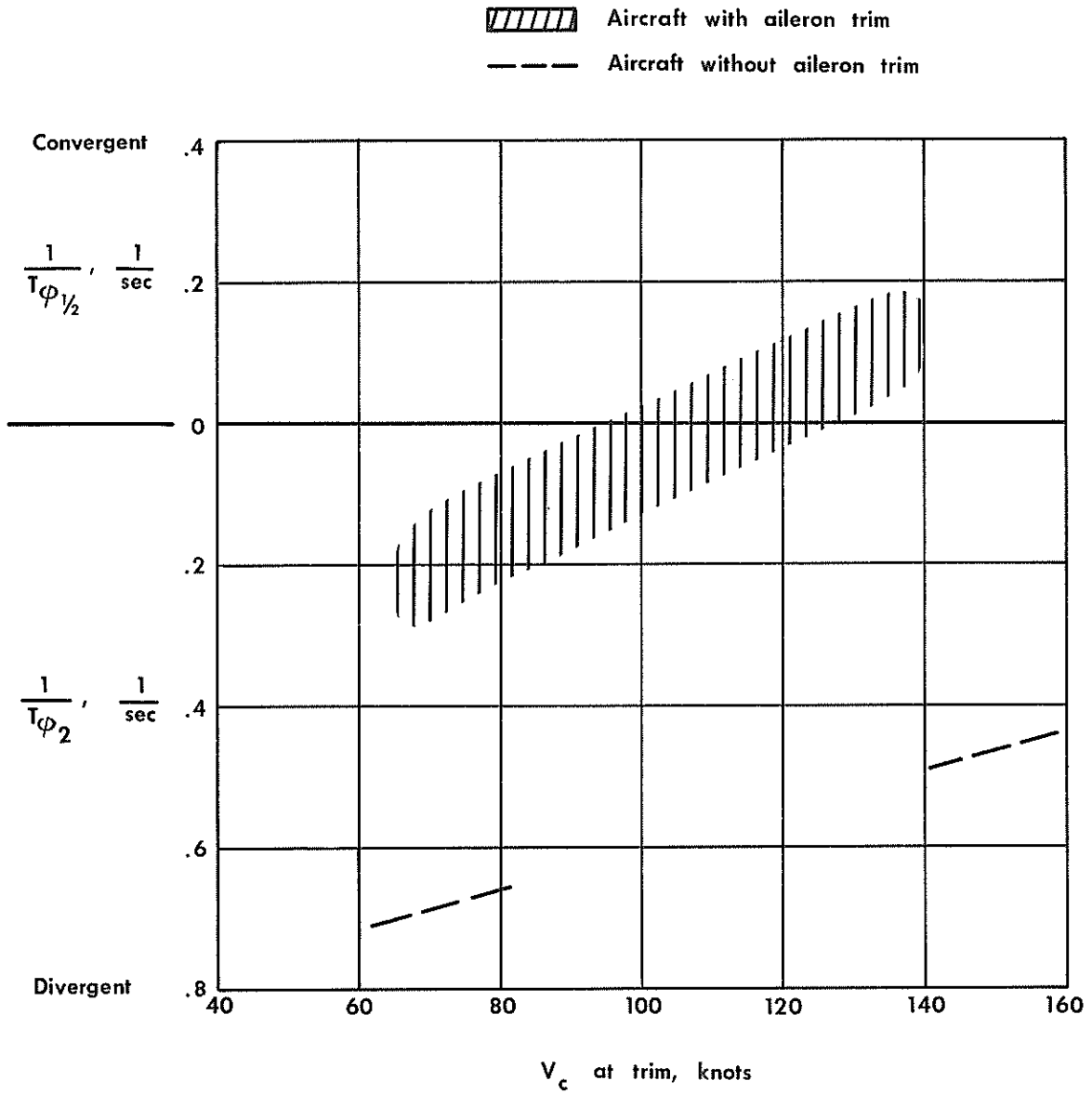

Figure 23.— Effect of aileron trim system on spiral characteristics of two aircraft without rudder trim capability. All configurations.

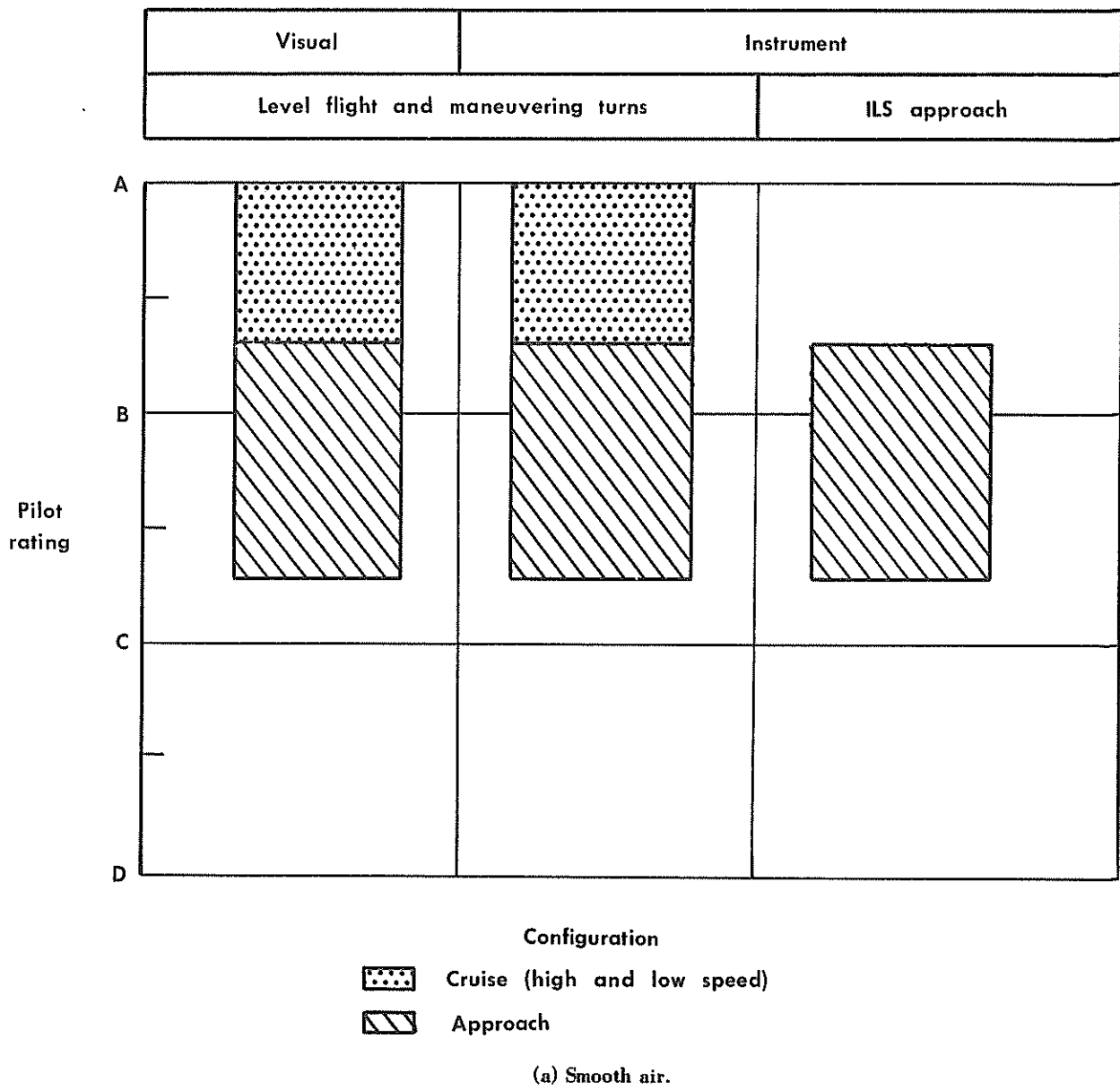
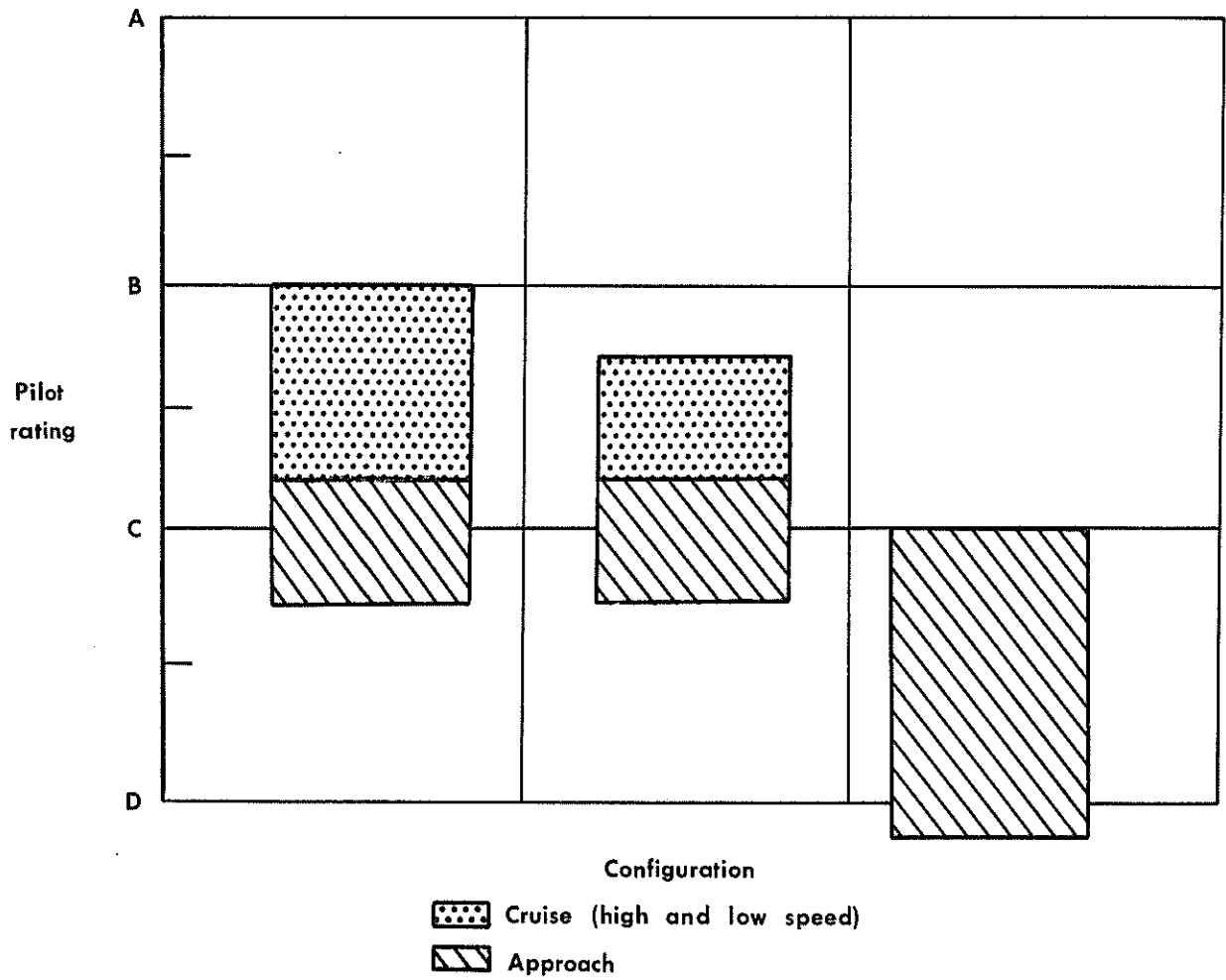

Figure 24.— Summary of pilot rating of the flying qualities of all the airplanes tested.

Visual	Instrument
Level flight and maneuvering turns	ILS approach



(b) Light-to-moderate turbulence.

Figure 24.— Concluded.

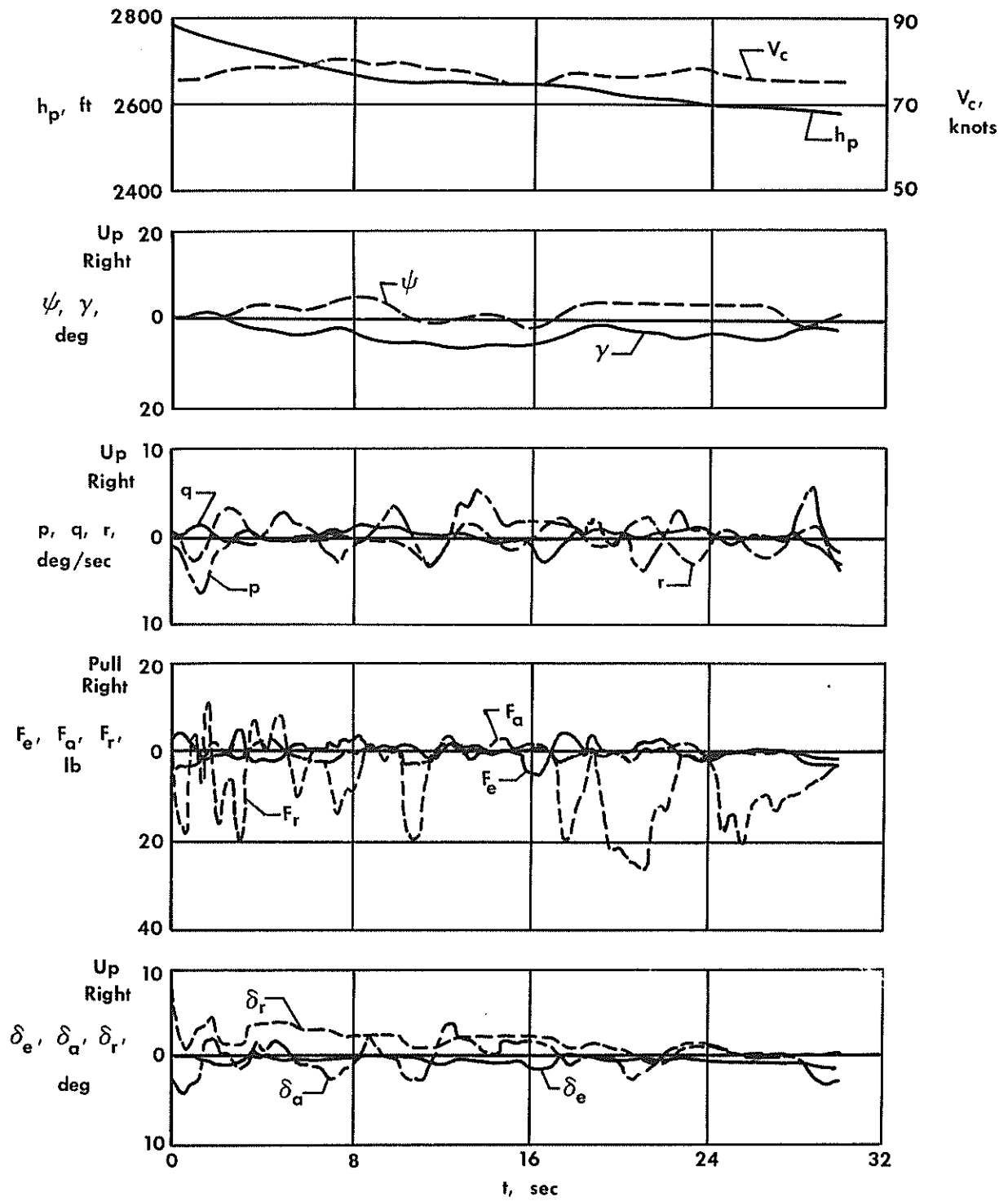

(a) Satisfactory aircraft.

Figure 25.— Time history of simulated ILS approach in very light turbulence.

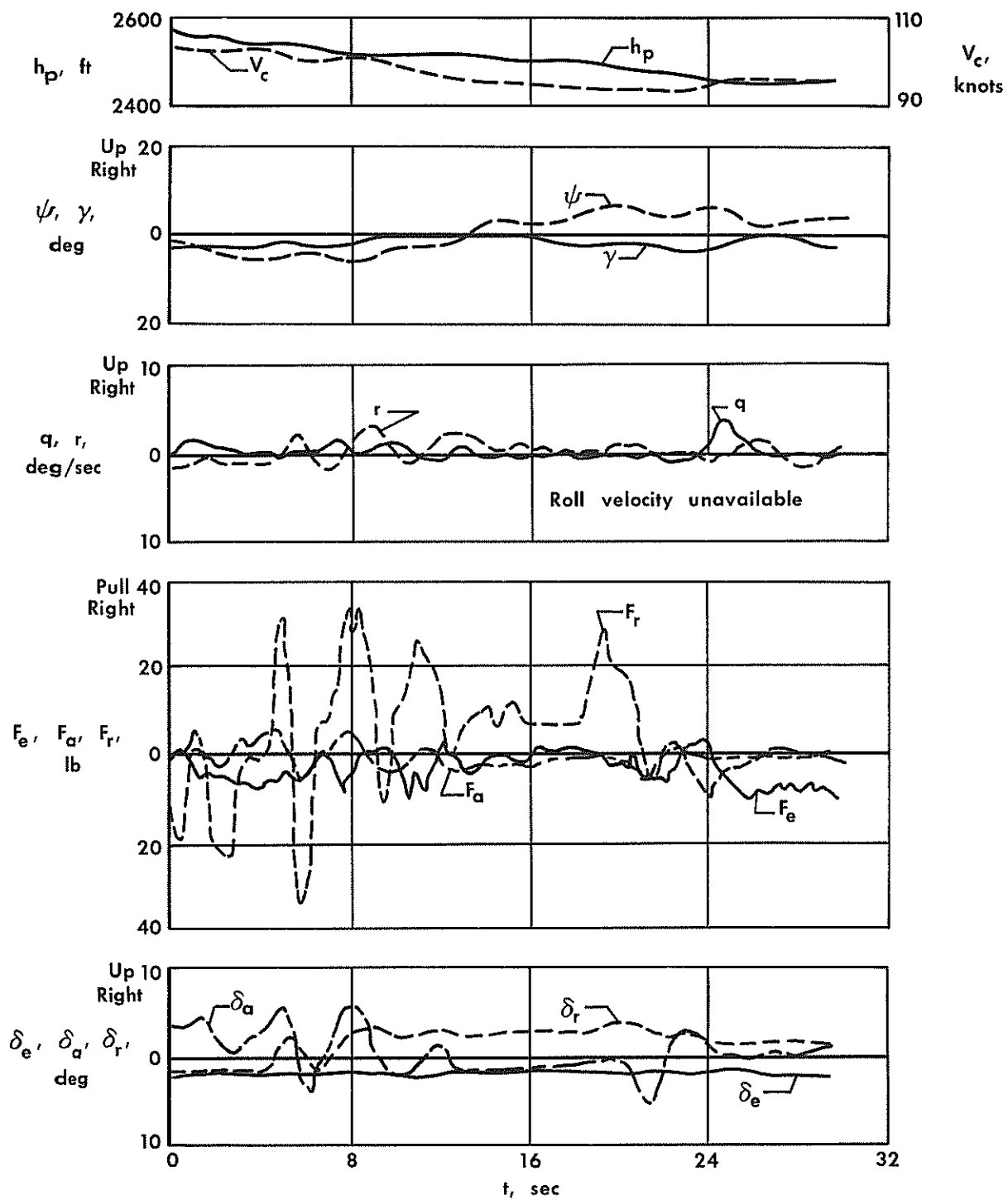

(b) Unsatisfactory aircraft.

Figure 25.— Concluded.

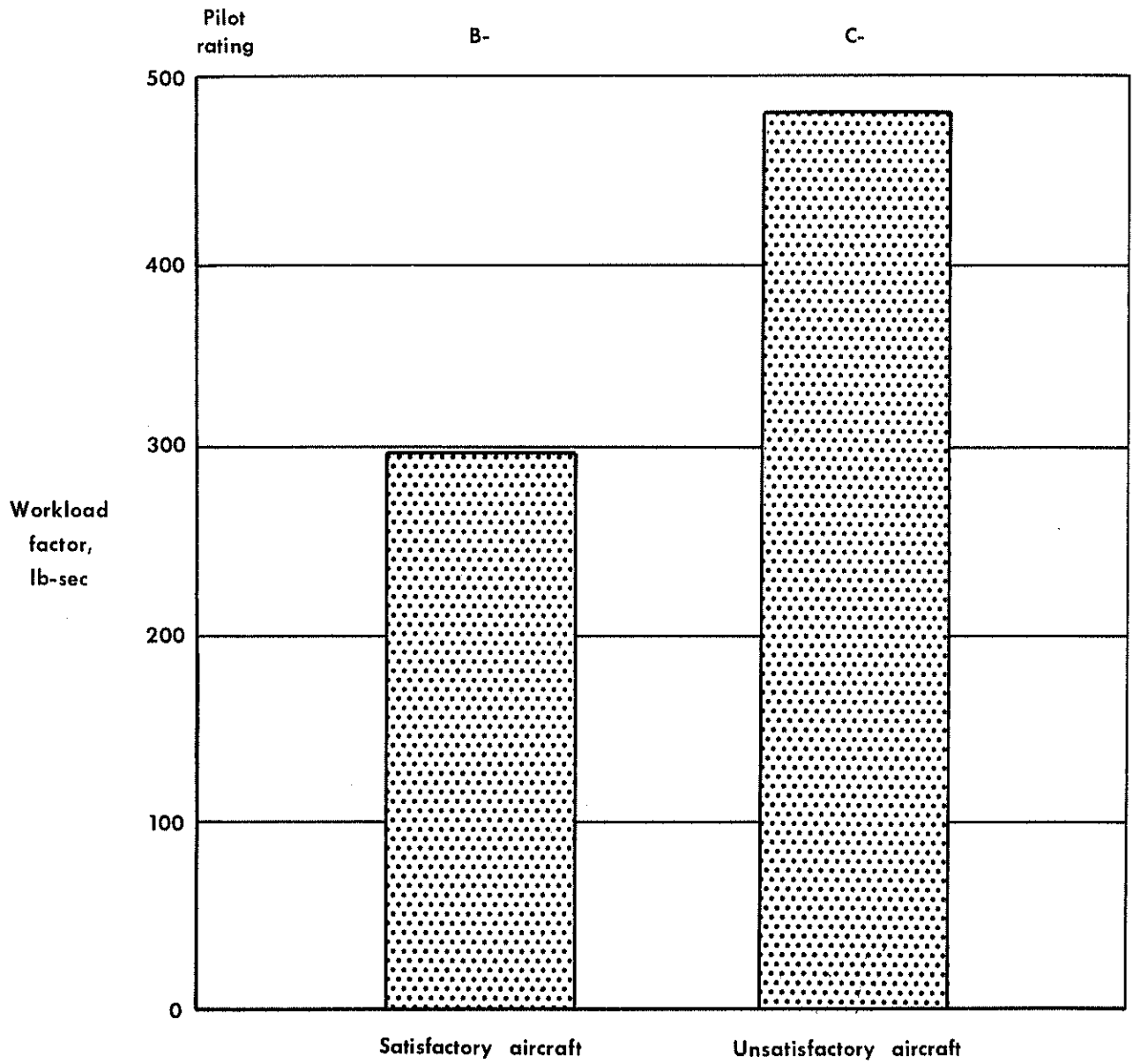

Figure 26.— Pilot workload for two airplanes during a simulated ILS approach.